

Life Is On

Schneider  
Electric



# Pricebook Retail 2021

Schneider Indonesia berdiri sejak

# 1973

(48 tahun)

Pemimpin Industri dalam indeks Dow Jones Sustainability (DJSI) selama 3 tahun berturut-turut dan "Industry Mover" untuk kemajuan proporsional terbaik pada performa keberlanjutannya dari tahun lalu

Sebagai pemimpin global di transformasi digital untuk manajemen energi dan otomasi, kami menciptakan teknologi terhubung yang:



+/- **5%** dari pendapatan disalurkan untuk Riset dan Pengembangan

**TAHUN 2020**

Perusahaan yang paling dikagumi di Dunia dari Fortune, untuk Industri Elektronik



**40%**  
Building & Partner

**29%**  
Industri

**17%**  
Infrastruktur

**14%**  
IT

**€26** miliar  
Pendapatan 2018

**€3,9** miliar  
EBITDA yang disesuaikan 2018

Life Is On

**Schneider**  
Electric

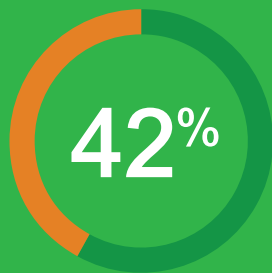

Pendapatan  
dari **EKONOMI  
BARU**



Pendapatan  
dari **IOT**

+/- **137,000**

Karyawan di 100 negara

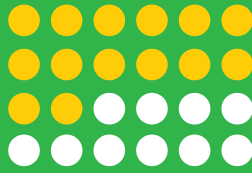

**30%** ♀

Karyawan  
kami adalah wanita

**Infrastruktur** Menciptakan jaringan  
distribusi di seluruh Indonesia



## SYARAT DAN KETENTUAN HARGA 2021

- Harga sudah termasuk PPN 10%
- Harga yang tercantum adalah harga satuan
- Harga dan Status Stok dapat berubah sewaktu-waktu tanpa pemberitahuan terlebih dahulu



**SNI  
AWARD  
WINNER  
SEJAK 2011**

Standarisasi SNI  
untuk Kotak Kontak



04-3892.1-2006

Standarisasi SNI  
untuk Sakelar



04-6203.1-2006

Sakelar dan kotak kontak paling diminati  
untuk proyek rumah tinggal

# Daftar Isi

Pricebook Retail 2021

Infografik 2

Daftar Isi 4

6

Leona

Sakelar untuk semua rumah



Wiser 14

10

AvatarOn

Sakelar dengan personalisasi cover



Zencelo 20

24

Pieno

Kombinasi sempurna antara estetika dan performa



28

Vivace

Sakelar Minimalis & Modern



S-Classic 30

Kavacha 32

Argus 36

Neo 38

Mobiya 42

## 44 Domae



## 46 RCCB

Pastikan rumah Anda terlindungi dari kesetrum dengan menggunakan RCCB Domae dari Schneider Electric



## 52 Industrial Plug Socket



## 49 Mini Pragma

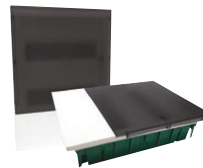

Easy Pact TVS 54

Power Logic 56

Harmony  
Push Button  
dan Signaling 58



# Leona

Sakelar untuk semua rumah



# Dua cara pemasangan

Menggunakan 2 pilihan cara pemasangan, dengan sistem pencakar atau sekrup.

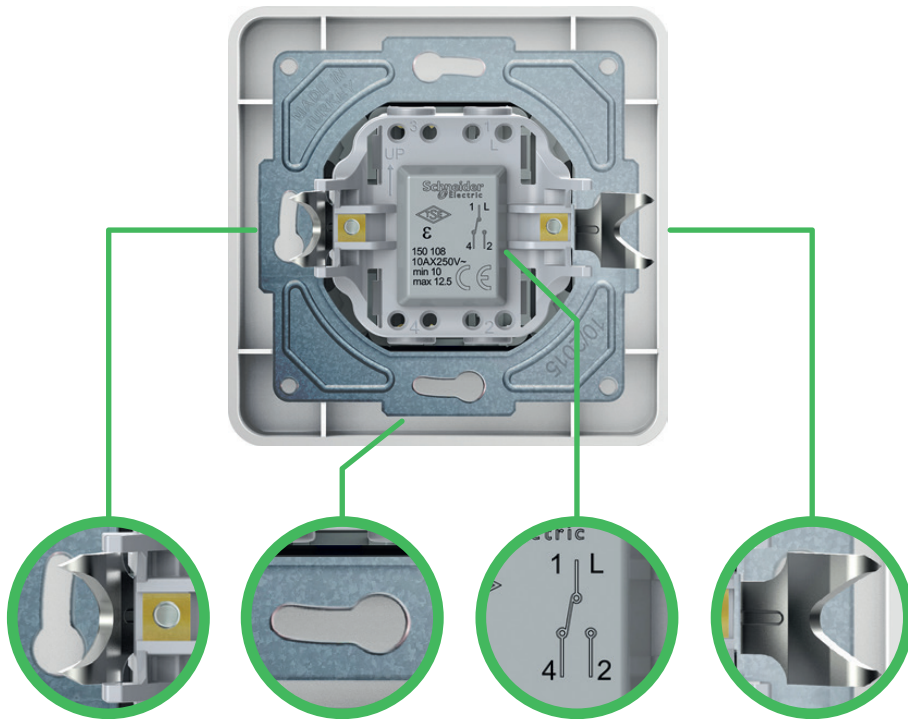

## Pemasangan yang mudah

Disesuaikan dengan kebutuhan Anda, pemasangan bisa dilakukan dengan sistem sekrup atau pencakar

## Instruksi lengkap

Diagram perkabelan tercetak di bagian dalam produk.

## Cakar penahan yang kuat

Bagian pencakar yang optimal untuk pemasangan yang kuat

## Performa maksimal untuk rumah Anda

- Frame modul terbuat dari logam, menjamin kualitas, kekuatan, dan tahan lama.
- Cakar terlindungi, menjamin kekuatan dan daya cengkram pada inboard, sehingga bertahan lebih lama.
- Modul terbuat dari *polycarbonate* berkualitas, lebih aman karena lebih tahan panas.



Dua cara pemasangan mudah, sistem pencakar atau sekrup



Konstruksi mekanikal kuat & tahan lama



Desain stylish & minimalis









## Leona



Jenis	Keterangan	Referensi	Pak	Harga
SAKELAR	10AX Sakelar 1 Gang - 1 Arah	LNA0100321	10	19.250
	10AX Sakelar 1 Gang - 2 Arah	LNA0400321	10	24.750
	10AX Sakelar 2 Gang - 1 Arah	LNA0300321	10	23.540
	10AX Sakelar 2 Gang - 2 Arah	LNA0600321	10	36.300
	10AX Sakelar 3 Gang - 1 Arah	LNA2100321	10	39.710
	10AX Sakelar Perantara (Intermediate)	LNA0500321	10	66.220
	16AX 1 Gang Sakelar Bel dengan indikato	LNA0800321	10	41.470
KOTAK KONTAK	16A 1 Gang Kotak Kontak Tipe Schuko tanpa Child Protection	LNA2900121	10	19.250
	16A 1 Gang Kotak Kontak Tipe Schuko dengan Child Protection	LNA2900221	10	23.540
	2 GANG SCHUKO CP	LNA9100221	6	53.570
	FRAME DOUBLE DENGAN 1 SCHUKO CP + KOSONG	LNA9000221	9	32.230
	FRAME TRIPLE DENGAN 1 SCHUKO CP + 2 KOSONG	LNA9200221	7	34.870
STOP KONTAK DATA, TV, TELEPON	Stop Kontak TV	LNA3200121	10	50.930
	Stop Kontak Telepon	LNA4100121	10	53.020
	Stop Kontak Data RJ45 Cat 5	LNA4300121	10	67.540
	Stop Kontak Data RJ45 Cat 6	LNA4700121	10	83.710
	CAT 6 & TELP SOCKET	LNA4900121	10	108.240
PEREDUP LAMPU	600W Peredup Lampu (Dimmer)	LNA6800121	10	330.440
	ENERGY SAVER CARD HOTEL	LNA1900221	8	216.370
	2 GANG USB CHARGER MAX 2.1A	LNA4500121	10	270.380
	2 Gang Universal Frame	LNA5800221	25	9.900
	3 Gang Universal Frame	LNA5800321	15	12.430
	1 Gang Outbow Leona	OBL838348	-	11.990



## Box, Aksesori dan Floor Socket

Gambar	Keterangan	Referensi	Pak	Harga
	220V 2-Wire Mechanical Door Chime	<b>99AC220</b>	1	159.280
	1 Gang Outbow Leona	<b>OBL838348</b>	1	11.990
	Wall Box, Black	<b>SWB_727245</b>	1	4.070
	Mounting Box W/O Term	<b>E238</b>	1	28.050
	2 Gang Surface Mount Polycarb Wallbox	<b>E238_2</b>	1	65.560
	2 Gang DP Mount'g Box	<b>ET238D</b>	1	75.900

### Floor Socket

	Empty Floor Skt W/ Box, IP44, DPG, Silver Color	<b>E227F_ABE</b>	1	529.210
	Empty Floor Skt W/ Box, IP44, DPG, Brass Color	<b>E227F_BAS</b>	1	603.460

### S-Flexi

	Universal Socket 3 Pin 13A, 250V, Size M	<b>F1426UAM</b>	32	40.810
	Universal Socket 2 Pin 10 A, 250 V, Size M	<b>F1426USM</b>	32	51.700
	Universal Socket 2 Pin 10 A, 250 V Size S	<b>F30426USM</b>	30	33.880
	Data Cat5E Communication Outlet	<b>F50RJ5EM</b>	30	85.250
	TV Koaksial Socket	<b>F50TVM</b>	30	49.390
	TV Koaksial Socket	<b>F30TVSM</b>	30	61.490
	4PIN RJ11 TEL Socket, Tanpa Penutup	<b>F30R4M</b>	30	58.410
	CAT5E Data Communication, Tanpa Penutup	<b>F30RJ5EM</b>	30	78.100

### Dimensi



Floor box metal:

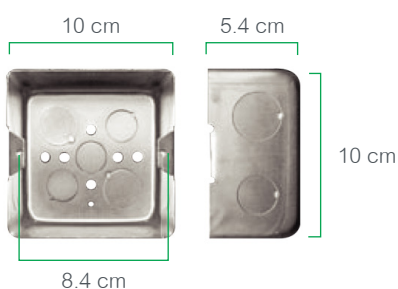

- Tersedia dalam 2 pilihan material Aluminium dan Kuningan (Brass)
- Berbagai pilihan dan kombinasi modul, termasuk untuk telekomunikasi
- Dilengkapi dengan Floor Box
- Daya tahan tinggi
- Konstruksi kuat
- IP44



# AvatarOn

Sakelar dengan personalisasi cover

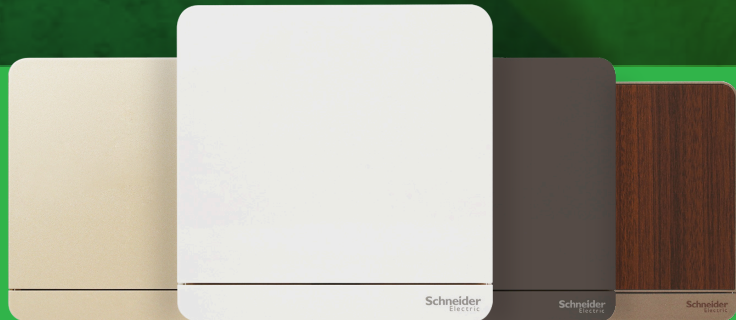

# Inovasi desain Dan teknologi

Pada 2017, AvatarOn mendapatkan Penghargaan Desain iF yang bergengsi, salah satu dari segel keunggulan desain, kualitas, dan kepercayaan desain yang paling diakui dan diakui dunia.

Dengan SS Mechanism Switch, sudut sakelar hanya 3 derajat, menghasilkan suara yang halus dan mengurangi resiko terjadinya loncatan api listrik.

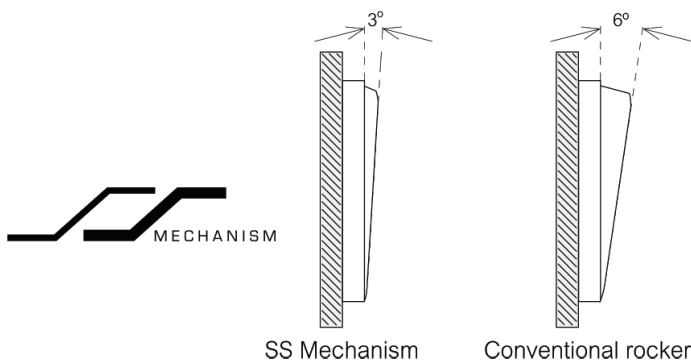

## LED Locator

Dilengkapi dengan LED locator yang berpendar lembut, sakelar AvatarOn tidak mengganggu di siang hari dan berpendar di malam hari



## Innovative Interchangeable Cover



Jenis	Gambar	Keterangan	Referensi	WE*	WG*	DG*	WD*
SAKELAR HORIZONTAL		16AX 250V 1G 1W Sw w LED	<b>E8331L1LED_**_G3</b>	83.380	108.350	108.350	141.570
		16AX 250V 1G 2W Sw w LED	<b>E8331L2LED_**_G3</b>	105.710	122.540	122.540	159.500
		16AX 250V 1G Intermediate Sw	<b>E8331M_WE_G3</b>	113.850	132.220	132.220	152.460
		4A 250V 1G Momentary Sw	<b>E8331PRL1_**_G3</b>	78.650	91.740	91.740	114.400
		16AX 250V 2G 1W Sw w LED	<b>E8332L1LED_**_G3</b>	123.200	148.720	148.720	193.930
		16AX 250V 2G 2W Sw w LED	<b>E8332L2LED_**_G3</b>	160.930	185.680	185.680	214.170
		4A 250V 2G Momentary Sw	<b>E8332PRL1_**_G3</b>	123.090	142.340	142.340	177.100
		16AX 250V 3G 1W Sw w LED	<b>E8333L1LED_**_G3</b>	163.900	189.200	189.200	246.290
		16AX 250V 3G 2W Sw w LED	<b>E8333L2LED_**_G3</b>	188.540	217.800	217.800	261.800
		4A 250V 3G Momentary Sw	<b>E8333PRL1_**_G3</b>	165.990	191.620	191.620	249.920
16AX 250V 4G 1W Sw w LED		<b>E8334L1LED_**_G3</b>	178.970	205.810	205.810	297.440	
16AX 250V 4G 2W Sw w LED		<b>E8334L2LED_**_G3</b>	203.720	234.410	234.410	339.130	
SAKELAR BEL		10A 250V 1G BP Sw	<b>E8331BPL1_**_G3</b>	164.560	236.830	236.830	274.340
DIMMER		1G 250VA Dimmer w Sw	<b>E8331RD250_**</b>	475.860	618.640	618.640	804.210
KOTAK KONTAK		16A Schuko Socket	<b>E83426_16S_**_G3</b>	100.430	115.500	115.500	133.320
		16A250V1Gang international Skt	<b>E83426TS_**</b>	205.370	336.050	336.050	437.470
		13A 250V 1G SW Skt w LED	<b>E8315N_**</b>	132.880	162.140	162.140	183.370
KOTAK KONTAK DATA, TV, TELP		1G TV Socket 75Ohm Through-Connect	<b>E8331TV_**</b>	106.700	139.260	139.260	160.710
		1G TEL Socket Shuttered Wallplate	<b>E8331RJS4_**</b>	105.710	138.050	138.050	159.500
		1G RJ45 Data CAT5E Shuttered	<b>E8331RJS5_**</b>	107.580	140.470	140.470	161.810
		1G RJ45 Data CAT6 Shuttered	<b>E8331RJS6_**</b>	109.450	142.780	142.780	164.230
STOP KONTAK HDMI		HDMI + USB SOCKET (Media)	<b>E8332HDUSB_**</b>	428.340	591.580	591.580	-
		2G HDMI + HDMI KEYSTONE	<b>E8332HDHD_**</b>	556.820	769.560	769.560	-
USB CHARGER		16A Int Socket with 2.1A USB	<b>E8342616USB_**</b>	535.370	615.670	615.670	713.790
		2 x 2.1A USB Charger	<b>E8332USB_**</b>	890.890	1.089.110	1.089.110	1.252.900
		21W Type A+C, PD+QC3.0 USB Charger	<b>E8332ACQUSB_*</b>	1.069.530	1.232.000	1.232.000	1.601.600
AKSESORI HOTEL		DND, PCU, PW Ind w Bell SW	<b>E8331BPDMW_**</b>	231.990	267.740	267.740	308.220
		16AX 3G Sw with PCU, DND, PW Sym	<b>E8333DMWS_**</b>	237.930	294.910	294.910	336.710
		250V 16A Elec Keycard SW w ID	<b>E8331EKTID_**</b>	1.190.200	1.546.600	1.546.600	-
		250V 16A Elec Keycard SW	<b>E8331EKT_**</b>	674.960	726.880	726.880	836.330
		115/240V 20VA Uni Ver Shaver	<b>E83T727V_**</b>	818.290	941.490	941.490	1.083.830



Jenis	Gambar	Keterangan	Referensi	WE*	WG*	DG*	WD*
BLANK COVER PLATE		1G Blank Plate	<b>E8330X_**</b>	41.030	47.630	47.630	83.380
		1G Sw Cover	<b>E8331_**</b>	42.900	61.930	61.930	119.020
		1G Sw Cover w Keyholder	<b>E8331KH_**</b>	52.360	76.230	76.230	142.780
		2G Sw Cover	<b>E8332_**</b>	52.360	64.790	64.790	154.660
		3G Sw Cover	<b>E8333_**</b>	57.200	82.170	82.170	178.530
		3G Sw Cover w Keyholder	<b>E8333KH_**</b>	61.930	95.260	95.260	208.230
		4G Sw Cover	<b>E8334_**</b>	61.930	75.900	75.900	214.170
FRAME		2G Bracket	<b>E8331_26_**</b>	37.510	59.510	59.510	89.320
		3G Bracket	<b>E8331_36_**</b>	49.940	71.390	71.390	116.600
		4G Bracket	<b>E8331_46_**</b>	60.060	83.380	83.380	124.960
		5G Bracket	<b>E8331_56_**</b>	72.160	101.640	101.640	134.530

## Kualitas Material Superior

Material dengan standar CCC, BS dan SNI, serta telah memenuhi Pedoman Pembatasan Bahan Berbahaya (RoHS)

Pengamanan tambahan: memastikan kualitas operasional

Pemasangan serta peroperasian mudah



Berbahan baku kualitas tinggi dengan proteksi anti UV sehingga warna terlindungi, tahan lama serta tidak berubah warna seiring dengan berjalannya waktu

Menggunakan material Bayer PC (Polycarbonate) yang tahan banting, tahan panas, tidak merambatkan api serta anti karat.

**Bahan Baku Premium**, kualitas terbaik dan ramah lingkungan



# Wiser

Definisikan ulang zona nyaman Anda

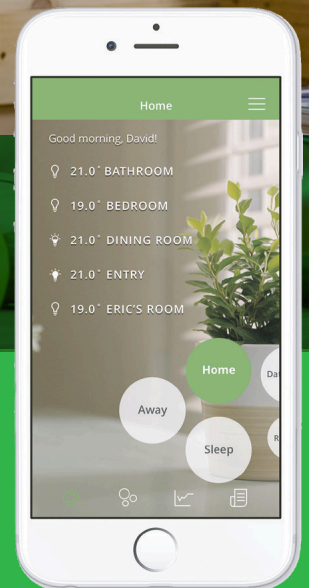
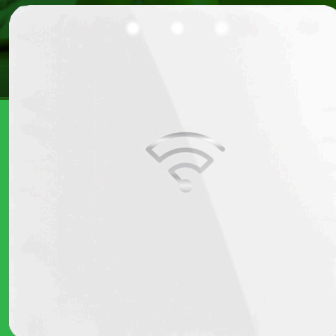

Wiser by SE app



# Wiser™

Connected Technology for Homes

Freelocate Switch

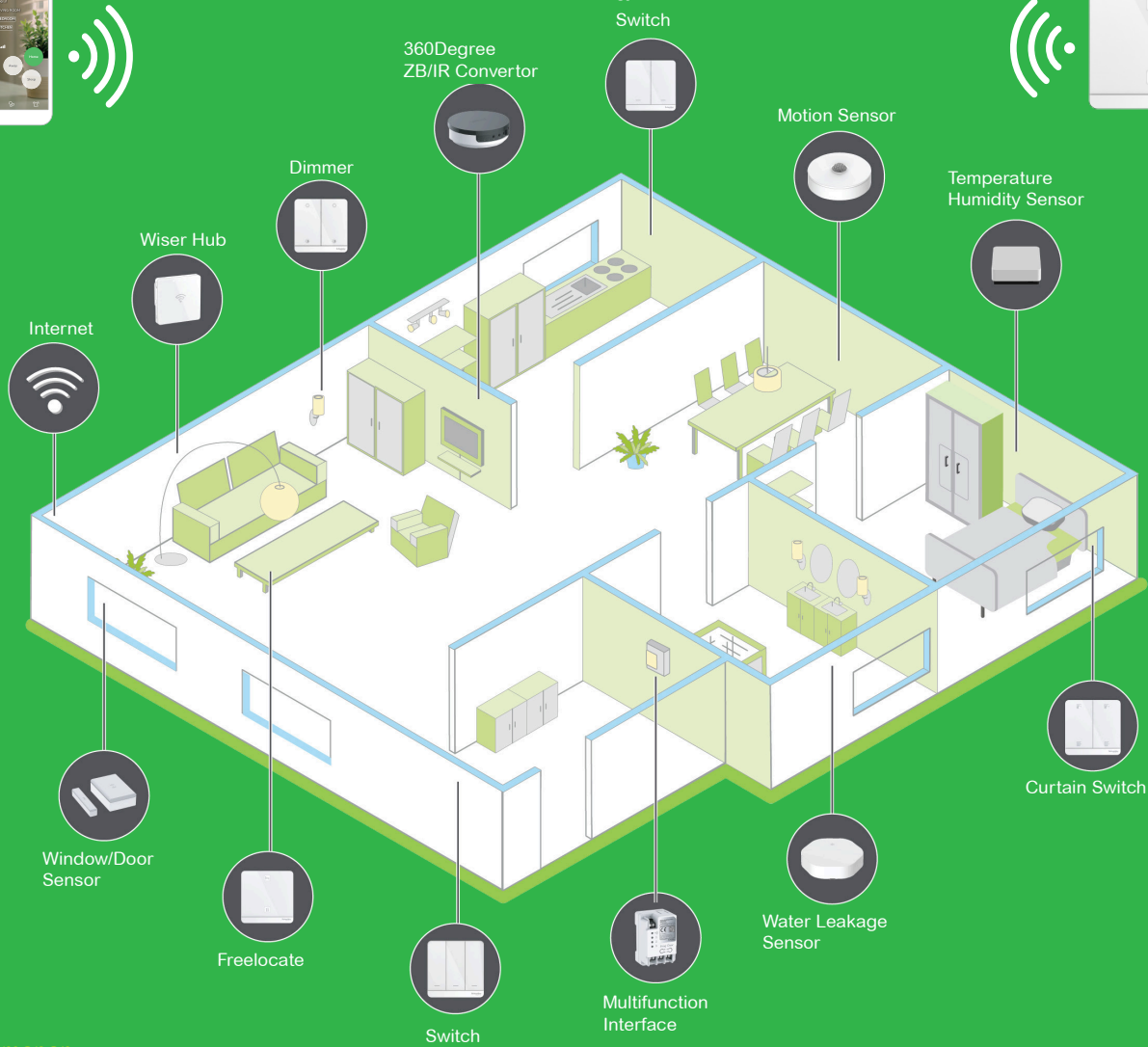

### Kenyamanan

Ciptakan momen yang ideal untuk setiap ruangan di rumah Anda dengan pengaturan suhu dengan pengotomasiannya rutinitas harian Anda.

### Suasana

Ciptakan suasana pencahayaan di ruangan Anda dengan menyalakan dan meredupkan lampu sesuai dengan suasana hati dan aktifitas Anda. Pengaturan pencahayaan bisa dilakukan secara individual ataupun dikelompokkan dengan perangkat lain seperti tirai ataupun pendingin ruangan.

### Ketenangan Pikiran

Berinvestasi pada sistem Wiser memberi Anda ketenangan pikiran. Aplikasi Wiser by SE dapat diprogram untuk menginformasikan Anda mengenai perubahan di rumah Anda. Pada saat terjadi kebocoran air, alarm akan berbunyi dan Anda akan menerima pemberitahuan pada perangkat seluler Anda. Halaman riwayat menampilkan informasi perubahan suhu, buka tutup jendela/pintu, dan deteksi pergerakan. Fitur sederhana namun efektif ini menciptakan lingkungan rumah yang aman dan damai.

### Sakelar Estetis untuk rumah Anda yang terhubung

Manfaatkan sepenuhnya fungsi yang ditawarkan rumah terhubung Anda, di setiap ruangan dengan desain sakelar AvatarOn,

Sakelar Wiser AvatarOn tersedia dalam 2 varian warna, Putih dan Gold.



Indikator LED di bagian depan sakelar dapat diatur menjadi warna biru atau putih untuk menyesuaikan tema kamar Anda.

Untuk kebutuhan produk WISER AvatarOn, silakan menghubungi Customer Service kami di **1500055**



# USB Charger

Vivace, Pieno, Zencelo, Neo, AvatarOn







- **Proses Charging Cepat**

Output 2.1A per outlet, 2 Gang USB max 4.2A.  
Tersedia Quick charge Type A + C QC - 21 W Max.

- **Energy Efficiency**

Fitur keamanan dan perlindungan memastikan pengisian daya ke gadget Anda aman & Efisien.

- **Fitur Perlindungan**



Perlindungan terhadap panas berlebih





Perlindungan terhadap arus tidak stabil





Perlindungan terhadap tegangan tidak stabil

## USB Charger Type A Warna Putih (Body Putih, LED Putih)

### 2.1 A Fast charging setiap Modulnya

Jenis	Gambar	Family - Warna	Referensi	Harga
1 Gang USB Chargers 2.1A		Vivace	<b>KB31USB_WE</b> 1	361.020
		Pieno, Putih	<b>E8231USB_WE</b>	451.880
	Pieno, Lavender Silver	<b>E8231USB_LS</b> 2	497.750	
	Zencelo, Putih	<b>E8431USB_WE</b>	543.730	
	Zencelo, Silver Bronze	<b>E8431USB_SZ</b>	600.710	
	Neo, Putih	<b>E3031USB_WW</b>	641.190	
	Neo, Grey Silver	<b>E3031USB_GS</b>	684.640	
2 Gang USB Chargers 2 x 2.1A		Vivace	<b>KB32USB_WE</b>	737.220
		Pieno, Putih	<b>E8232USB_WE</b>	895.070
		Pieno, Lavender Silver	<b>E8232USB_LS</b>	925.760
	Zencelo, Putih	<b>E8432USB_WE</b> 3	1.082.180	
	Zencelo, Silver Bronze	<b>E8432USB_SZ</b>	1.120.790	
	Neo, Putih	<b>E3032USB_WW</b>	1.247.400	
	Neo, Grey Silver	<b>E3032USB_GS</b>	1.284.800	
		AvatarOn, Putih	<b>E8332USB_WE</b>	890.890
		AvatarOn, Wine Gold	<b>E8332USB_WG</b> 4	1.089.110
		AvatarOn, Dark Grey	<b>E8332USB_DG</b>	1.089.110
AvatarOn, Dark Wood		<b>E8332USB_WD</b>	1.252.900	

## International Socket + 2.1 A USB

Jenis	Gambar	Family - Warna	Referensi	Harga
International Socket + 2.1 A USB		Vivace	<b>KB42616USB_WE</b>	424.490
		Pieno, Putih 5	<b>E8242616USB_WE</b>	475.860
		Pieno, Lavender Silver	<b>E8242616USB_LS</b>	535.370
		Zencelo, Putih	<b>E8442616USB_WE</b>	594.880
		Zencelo, Silver Bronze	<b>E8442616USB_SZ</b>	654.390
	Neo, Putih	<b>E342616USB_WW</b>	684.112	
	Neo, Grey Silver	<b>E342616USB_GS</b>	752.549	
	AvatarOn, Putih	<b>E8342616USB_WE</b>	535.370	
		AvatarOn, Wine Gold 6	<b>E8342616USB_WG</b>	615.670
		AvatarOn, Dark Grey	<b>E8342616USB_DG</b>	615.670
AvatarOn, Dark Wood		<b>E8342616USB_WD</b>	713.790	

## Type A + C QC - 21 W Max

Jenis	Gambar	Family - Warna	Referensi	Harga
Type A + C QC - 21 W Max		Vivace	KB32ACQUSB_WE	758.010
		Pieno, Putih <b>7</b>	E8232ACQUSB_WE	951.720
		Pieno, Lavender Silver	E8232ACQUSB_LS	1.011.230
		Zencelo, Putih <b>8</b>	E8432ACQUSB_WE	1.117.490
		Zencelo, Silver Bronze	E8432ACQUSB_SZ	1.179.640
		Neo, Putih	E3032ACQUSB_WW	1.270.500
		Neo, Grey Silver	E3032ACQUSB_GS	1.398.100
		AvatarOn, Putih <b>9</b>	E8332ACQUSB_WE	1.069.530
		AvatarOn, Wine Gold	E8332ACQUSB_WG	1.232.000
		AvatarOn, Dark Grey	E8332ACQUSB_DG	1.232.000
		AvatarOn, Dark Wood	E8332ACQUSB_WD	1.601.600

## BARU dari Schneider Electric!

- Soket USB pertama dan satu-satunya yang terdaftar di Qualcomm “Wall-mounted QC USB” (Qualcomm Quick Charge Technology Device List version 03/2019)
- Ketika Soket Type A telah selesai mengisi ulang daya, soket Type C akan secara otomatis mengubah isi ulang daya menjadi “Fast Charge” (**Schneider Electric patented**).
- Type A or Type C alone, 5V 3A, 9V 2A, 12V 1.5A
- Type A and Type C, 5V 2.4A Max for every port



# ZENcelo

Sakelar dan kotak kontak datar pertama di dunia

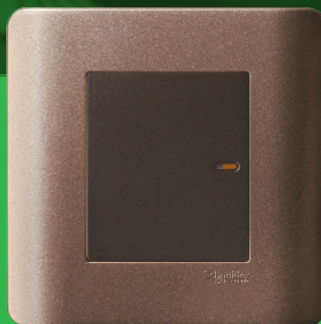

# Sakelar datar pertama di dunia

- Mekanisme 'impress' (iso-motion-press) yang telah dipatenkan memastikan bingkai sakelar tetap statis, baik ketika dalam posisi 'ON' atau 'OFF'.
- Sakelar diuji sebanyak 80.000 kali (2 kali lebih banyak dari standar internasional).



Penggunaan penanda cahaya fluorescent white on white sebagai salah satu fitur eksklusif dari ZENcelo.

## Kualitas & Keamanan yang Dirancang Tahan Lama

- Setiap bagian dilindungi oleh lapisan *polyurethane* untuk menjamin reabilitas produk.
- Terbuat dari material *polycarbonate* tahan karat, panas, serta benturan



Jenis	Gambar	Keterangan	Referensi	Pak	Harga
SAKELAR		16AX Sakelar Datar 1 Gang 1 Arah dengan Indikator, Putih	<b>E8431_1_WE_G3</b>	8	57.750
		16AX Sakelar Datar 1 Gang 2 Arah, Putih	<b>E8431_2_WE_G3</b>	8	89.210
		16AX Sakelar Datar 2 Gang 1 Arah dengan Indikator, Putih	<b>E8432_1_WE_G3</b>	8	91.190
		16AX Sakelar Datar 2 Gang 2 Arah, Putih	<b>E8432_2_WE_G3</b>	8	134.970
		16AX Sakelar Datar 3 Gang 1 Arah dengan Indikator, Putih	<b>E8433_1_WE_G3</b>	8	161.810
		16AX Sakelar Datar 3 Gang 2 Arah, Putih	<b>E8433_2_WE_G3</b>	8	219.560
		16AX 4 Gang 1 Arah Sakelar Datar dengan Indikator, Putih	<b>E8434_1_WE_G3</b>	8	180.180
	20A 1 Gang Sakelar Ganda Datar Neon, Putih	<b>E8431D20_WE</b>	8	159.280	
		10A Sakelar Bel Datar, Putih	<b>E8431BP1</b>	10	195.250
KOTAK KONTAK		16A 1 Gang Kotak Kontak Tipe Schuko, Putih	<b>E84426_16S_WE_G3</b>	6	70.180
		16A 2 Gang Kotak Kontak Tipe Schuko, Putih	<b>E84T426_16S_WE_G3</b>	4	110.220
		16A 1 Gang Kotak Kontak Internasional, Putih	<b>E84426_16TS_C15426</b>	8	149.380
		13A 1 Gang Kotak Kontak dengan Sakelar, Neon, Putih	<b>E8415N</b>	8	169.840
USB CHARGER		1 x 2.1A USB Charger, WE	<b>E8431USB_WE</b>	8	543.730
		2 x 2.1A USB Charger, WE	<b>E8432USB_WE</b>	8	1.082.180
		International Socket + 2.1 A USB	<b>E8442616USB_WE</b>	8	594.880
		USB Charger Type A + C QC - 21 W Max	<b>E8432ACQUSB_WE</b>	8	1.117.490
PLAT PENUTUP		1 Gang Plat Penutup, Putih	<b>E8430X_WE</b>	12	34.870
FRAME GRID PLATE		Frame Tengah Reguler dengan konektor	<b>E8403_35</b>	16	32.780
		Frame Tepi Reguler dengan konektor	<b>E8403_36</b>	16	32.780
		Frame Tengah Panjang dengan konektor - untuk USB Charger	<b>E8403_37_WE</b>	16	32.780
		Frame Tepi Panjang dengan konektor - untuk USB Charger	<b>E8403_38_WE</b>	16	32.780
KOTAK KONTAK TV, TELEPON DAN DATA		1 Gang Kotak Kontak Soket TV, Master, Putih	<b>E8431TVM_WE</b>	8	247.390
		1 Gang Kotak Kontak RJ11 4 Kawat Telepon Dengan Penutup, Putih	<b>E8431RJS4</b>	8	139.810
		1 Gang Kotak Kontak RJ45 Data Outlet Cat 5E, Putih	<b>E8431RJ_5</b>	8	264.110
		1 Gang Kotak Kontak RJ45 Data Outlet Cat 6, Putih	<b>E8431RJ_6</b>	8	342.650
PEREDUP LAMPU		1 Gang 350VA, 50Hz Peredup Lampu (Dimmer) Datar Universal LED, Putih	<b>E8431EPD4_WE</b>	6	1.141.800
AKSESORI HOTEL		Electronic Key Card Time Delay SW	<b>E8431EKT</b>	6	700.260
		1G Full-Flat SW W/DND Symbol	<b>E8431DS</b>	8	194.040
		2G Full-Flat SW w/DND & PCU Symbols	<b>E8432DMS_WE</b>	8	271.260
		1G Full-Flat Bell SW w/DND & PCU Symbols	<b>E8431BPDM</b>	8	279.840
		Universal Shaver Unit, Vertical	<b>E84T727V_WE</b>	1	965.580

# ZENcelo Warna Silver Bronze

Jenis	Gambar	Keterangan	Referensi	Pak	Harga
SAKELAR		16AX Sakelar Datar 1 Gang 1 Arah dengan Indikator, Silver Bronze	E8431_1_SZ_G3	8	105.600
		16AX Sakelar Datar 1 Gang 2 Arah, Silver Bronze	E8431_2_SZ_G3	8	147.400
		16AX Sakelar Datar 2 Gang 1 Arah dengan Indikator, Silver Bronze	E8432_1_SZ_G3	8	141.570
		16AX Sakelar Datar 2 Gang 2 Arah, Silver Bronze	E8432_2_SZ_G3	8	189.420
		16AX Sakelar Datar 3 Gang 1 Arah dengan Indikator, Silver Bronze	E8433_1_SZ_G3	8	201.190
		16AX Sakelar Datar 3 Gang 2 Arah, Silver Bronze	E8433_2_SZ_G3	8	273.240
		16AX 4 Gang 1 Arah Sakelar Datar dengan Indikator, Silver Bronze	E8434_1_SZ_G3	8	233.970
		20A 1 Gang Sakelar Ganda Datar Neon, Silver Bronze	E8431D20_SZ	8	173.030
KOTAK KONTAK		10A Sakelar Bel Datar, Silver Bronze	E8431BP1_SZ	10	267.410
		16A 1 Gang Kotak Kontak Tipe Schuko, Silver Bronze	E84426_16S_SZ_G3	6	127.160
		16A 2 Gang Kotak Kontak Tipe Schuko, Silver Bronze	E84T426_16S_SZ_G3	4	151.360
		16A 1 Gang Kotak Kontak Internasional, Silver Bronze	E8442616TS_C15426B	8	175.670
USB CHARGER		13A 1 Gang Kotak Kontak dengan Sakelar, Neon, Silver Bronze	E8415N_SZ	8	220.220
		1 x 2.1A USB Charger, SZ	E8431USB_SZ	8	600.710
		2 x 2.1A USB Charger, SZ	E8432USB_SZ	8	1.120.790
		International Socket + 2.1 A USB	E8442616USB_SZ	8	654.390
PLAT PENUTUP		USB Charger Type A + C QC - 21 W Max	E8432ACQUSB_SZ	8	1.179.640
		1 Gang Plat Penutup, Silver Bronze	E8430X_SZ	12	47.960
FRAME GRID PLATE		Frame Tengah Reguler dengan konektor	E8403_35S_SZ	16	52.470
		Frame Tepi Reguler dengan konektor	E8403_36S_SZ	16	52.470
		Frame Tengah Panjang dengan konektor - untuk USB Charger	E8403_37S_SZ	16	52.470
		Frame Tepi Panjang dengan konektor - untuk USB Charger	E8403_38S_SZ	16	52.470
KOTAK KONTAK TV, TELEPON DAN DATA		1 Gang Kotak Kontak Soket TV, Master, Silver Bronze	E8431TVM_SZ	8	314.050
		1 Gang Kotak Kontak RJ11 4 Kawat Telepon Dengan Penutup, Silver Bronze	E8431RJS4_SZ	8	183.810
		1 Gang Kotak Kontak RJ45 Data Outlet Cat 5E, Silver Bronze	E8431RJ_5_SZ	8	376.530
		1 Gang Kotak Kontak RJ45 Data Outlet Cat 6, Silver Bronze	E8431RJ_6_SZ	8	386.320
PEREDUP LAMPU		1 Gang 350VA, 50Hz Peredup Lampu (Dimmer) Datar Universal LED, Silver Bronze	E8431EPD4_SZ	6	1.314.500
AKSESORI HOTEL		Electronic Key Card Time Delay SW	E8431EKT_SZ	6	891.550
		1G Full-Flat SW W/DND Symbol	E8431DS_SZ	8	393.030
		2G Full-Flat SW w/DND & PCU Symbols	E8432DMS_SZ	8	315.810
		1G Full-Flat Bell SW w/DND & PCU Symbols	E8431BPDM_SZ	8	304.590
		Universal Shaver Unit, Vertical	E84T727V_SZ	1	995.610



# Pieno

Kombinasi sempurna antara  
estetika dan performa





# SS Mechanism Switch

Sudut sakelar hanya 3 derajat, menghasilkan suara yang halus dan mengurangi resiko terjadinya loncatan api listrik.

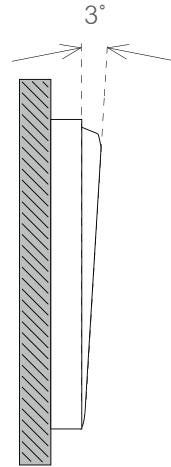

SS Mechanism

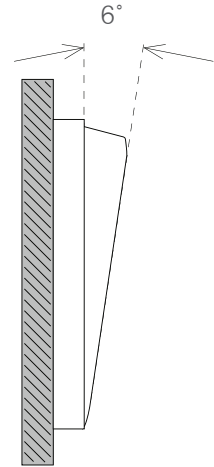

Rocker konvensional







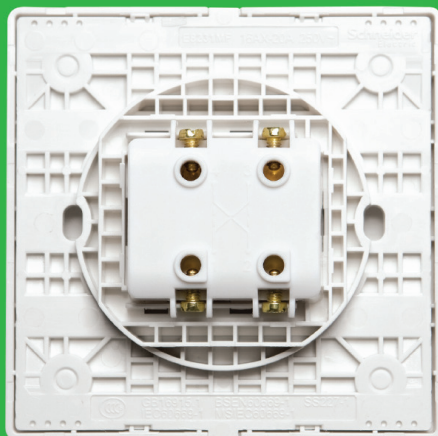























# PerfectFace® Switch Architecture

Penutup permukaan sakelar yang berguna untuk menjaga tampilan produk tetap sempurna saat proses pengecatan dinding.



Desain bagian belakang sakelar dirancang berbentuk lingkaran untuk memudahkan pemasangan pada dinding kayu dan furnitur.

Jenis	Gambar	Keterangan	Referensi	Pak	Harga
SAKELAR		16AX Sakelar 1 Gang 1 Arah, Fluoresen, Putih	E8231L1F_WE_G3	8	47.190
		16AX Sakelar 1 Gang 2 Arah, Fluoresen, Putih	E8231L2F_WE_G3	8	50.930
		16AX Sakelar 2 Gang 1 Arah, Fluoresen, Putih	E8232L1F_WE_G3	8	74.800
		16AX Sakelar 2 Gang 2 Arah, Fluoresen, Putih	E8232L2F_WE_G3	8	81.620
		16AX Sakelar 3 Gang 1 Arah, Fluoresen, Putih	E8233L1F_WE_G3	6	131.230
		16AX Sakelar 3 Gang 2 Arah, Fluoresen, Putih	E8233L2F_WE_G3	6	141.240
		16AX Sakelar 4 Gang 1 Arah, Fluoresen, Putih	E8234L1F_WE_G3	6	149.490
		16AX Sakelar 4 Gang 2 Arah, Fluoresen, Putih	E8234L2F_WE_G3	6	153.230
		16AX Sakelar 1 Gang Sakelar Intermediate, Putih	E8231MF_WE_G3	6	116.930
		10A 1 Gang Sakelar Bel, Putih	E8231BPL1_WE_G1	8	148.170
	10A 1 Gang Sakelar Momentary, Fluoresen, Putih	E8231PRL1F_WE_G3	8	49.610	
SAKELAR GANDA		20A 1 Gang Sakelar Ganda Neon, Putih	E8231D2ON_WE_G3	8	127.490
KOTAK KONTAK		16A 1 Gang Kotak Kontak Tipe Schuko, Putih	E82426_16S_WE_G3	8	64.790
		13 A 1 Gang Kotak Kontak dan Sakelar, Neon, Putih	E8215N_WE_G1	8	110.000
USB CHARGER		1 x 2.1 A USB Charger, WE	E8231USB_WE	8	451.880
		2 x 2.1A USB Charger, WE	E8232USB_WE	8	895.070
		International Socket + 2.1 A USB	E8242616USB_WE	8	475.860
		USB Charger Type A + C QC - 21 W Max	E8232ACQUSB_WE	8	951.720
PLAT PENUTUP		1 Gang Plat Penutup, Putih	E8230X_WE_G1	10	28.930
KOTAK KONTAK TV, TELEPON DAN DATA		1 Gang Kotak Kontak TV Soket, 75 Ohm, Putih	E8231TV_WE_G1	8	121.440
		1 Gang RJ11 4 Kawat Kotak Kontak Telepon Keystone dengan Penutup - Putih	E8231RJS4_WE_G1	8	124.410
		1 Gang Kotak Kontak RJ45 8 Kawat Data Outlet Cat. 5E Keystone dengan Penutup - Putih	E8231RJS_5_WE_G1	8	109.450
PEREDUP LAMPU		450 W 1 Gang Peredup Lampu (Dimmer) dengan Sakelar, Putih	E8232RD450U_WE_G1	8	679.360
AKSESORI HOTEL		250V 16A ELEC KEY CARD TIME DELAY SW	E8231EKT_WE_G1	6	625.790
		250V ILL DND, PCU, PW, SYM	E8231DMW_WE_G1	8	204.050
		250V 10A 1G BELL SW W ILL DND, PCU, PW SYM	E8231BPDMMW_WE_G1	8	219.780
		16AX 3G SW W NEON W DND, PCU, PW SYM	E8233DMWS_WE_G1	6	168.300
		115V/240V 20VA UNI SHAVER UNIT, HOR	E82T727H_WE_G1	1	773.190
		115V/240V 20VA UNI SHAVER UNIT, VRT	E82T727V_WE_G1	1	773.190

# Pieno Warna Lavender Silver

Jenis	Gambar	Keterangan	Referensi	Pak	Harga
SAKELAR		16AX Sakelar 1 Gang 1 Arah, Fluoresen, Lavender Silver	<b>E8231L1F_LS_G3</b>	8	89.870
		16AX Sakelar 1 Gang 2 Arah, Fluoresen, Lavender Silver	<b>E8231L2F_LS_G3</b>	8	122.430
		16AX Sakelar 2 Gang 1 Arah, Fluoresen, Lavender Silver	<b>E8232L1F_LS_G3</b>	8	101.200
		16AX Sakelar 2 Gang 2 Arah, Fluoresen, Lavender Silver	<b>E8232L2F_LS_G3</b>	8	171.490
		16AX Sakelar 3 Gang 1 Arah, Fluoresen, Lavender Silver	<b>E8233L1F_LS_G3</b>	6	181.500
		16AX Sakelar 3 Gang 2 Arah, Fluoresen, Lavender Silver	<b>E8233L2F_LS_G3</b>	6	220.330
		16AX Sakelar 4 Gang 1 Arah, Fluoresen, Lavender Silver	<b>E8234L1F_LS_G3</b>	6	190.300
		16AX Sakelar 4 Gang 2 Arah, Fluoresen, Lavender Silver	<b>E8234L2F_LS_G3</b>	6	206.580
SAKELAR GANDA		20A 1 Gang Sakelar Ganda Neon, Lavender Silver	<b>E8231D20N_LS_G3</b>	6	138.160
KOTAK KONTAK		16A 1 Gang Kotak Kontak Tipe Schuko, Lavender Silver	<b>E82426_16S_LS_G3</b>	8	106.150
		13A 1 Gang Kotak Kontak dan Sakelar, Neon, Lavender Silver	<b>E8215N_LS_G1</b>	8	159.500
USB CHARGER		1 x 2.1 A USB Charger, Lavender Silver	<b>E8231USB_LS</b>	8	497.750
		2 x 2.1A USB Charger, Lavender Silver	<b>E8232USB_LS</b>	8	925.760
		International Socket + 2.1 A USB	<b>E8242616USB_LS</b>	8	535.370
		USB Charger Type A + C QC - 21 W Max	<b>E8232ACQUSB_LS</b>	8	1.011.230
PLAT PENUTUP		1 Gang Plat Penutup, Lavender Silver	<b>E8230X_LS_G1</b>	10	39.050
KOTAK KONTAK TV, TELEPON DAN DATA		1 Gang Kotak Kontak TV, Lavender Silver	<b>E8231TV_LS_G1</b>	8	141.020
		1 Gang RJ11 Kotak Kontak Telepon Keystone dengan Penutup - Lavender Silver	<b>E8231RJS4_LS_G1</b>	8	202.840
		1 Gang Kotak Kontak RJ45 Data Outlet Cat. 5E Keystone dengan Penutup - Lavender Silver	<b>E8231RJS_5_LS_G1</b>	8	177.320
PEREDUP LAMPU		450 W 1 Gang Peredup Lampu (Dimmer) dengan Sakelar, Lavender Silver	<b>E8232RD450U_LS_G1</b>	6	681.670
AKSESORI HOTEL		250V 16A ELEC KEY CARD TIME DELAY SWITCH	<b>E8231EKT_LS_G1</b>	6	633.930
		250V ILL DND, PCU, PW SYMBOL	<b>E8231DMW_LS_G1</b>	6	230.340
		250V 10A 1G BELL SW W ILL DND, PCU, PW SYMBOL	<b>E8231BPDMMW_LS_G1</b>	6	244.860
		16AX 3G SW W NEON W DND, PCU, PW SYMBOL	<b>E8233DMWS_LS_G1</b>	6	248.600
		115V/240V 20VA UNI SHAVER UNIT, HORIZONTAL	<b>E82T727H_LS_G1</b>	1	809.600
		115V/240V 20VA UNI SHAVER UNIT, VERTICAL	<b>E82T27V_LS_G1</b>	1	809.600



# Vivace

Sakelar Minimalis & Modern



Jenis	Gambar	Keterangan	Referensi	Pak	Harga
SAKELAR		16AX Sakelar 1 Gang - 1 Arah	KB31_1_WE_G3	8	26.840
		16AX Sakelar 1 Gang - 2 Arah	KB31_WE_G3	8	34.210
		16AX Sakelar 2 Gang - 1 Arah	KB32_1_WE_G3	8	42.130
		16AX Sakelar 2 Gang - 2 Arah	KB32_WE_G3	8	53.460
		16AX Sakelar 3 Gang - 1 Arah	KB33_1_WE_G3	8	62.920
		16AX Sakelar 3 Gang - 2 Arah	KB33_WE_G3	8	69.080
		16AX Sakelar 4 Gang - 1 Arah	KB34S_1_WE_G3	8	100.760
		16AX Sakelar 4 Gang - 2 Arah	KB34S_WE_G3	8	115.390
		16AX Sakelar 4 Gang - 1 Arah (2 Gang Frame)	KB34_1_WE_G3	8	119.680
		16AX Sakelar 4 Gang - 2 Arah (2 Gang Frame)	KB34_WE_G3	5	132.880
SAKELAR GANDA		10AX 1 Gang Sakelar Intermediate	KB31IA_WE	5	94.710
		10A 1 Gang Sakelar Bell	KB31BPB	8	97.900
KOTAK KONTAK		20A 1 Gang Sakelar Ganda Neon	KB31D20NE_WE	8	76.560
		16A 1 Gang Kotak Kontak Tipe Schuko	KB426_16S_WE_G3	10	40.260
		13A 1 Gang Kotak Kontak Sakelar Neon	KB15N	8	85.030
USB CHARGER		13A 1 Gang Kotak Kontak Universal 3 pin	KB413S_C15329	10	51.920
		1 x 2.1A USB Charger, WE	KB31USB_WE	8	361.020
		2 x 2.1A USB Charger, WE	KB32USB_WE	6	737.220
		International Socket + 2.1 A USB	KB42616USB_WE	8	424.490
PLAT PENUTUP		USB Charger Type A + C QC - 21 W Max	KB32ACQUSB_WE	8	758.010
		1 Gang Plat Penutup	KB30_WE	15	25.630
AKSESORI BINGKAI		2 Gang Surround	KB_21_WE	15	19.800
		3 Gang Surround	KB_31_WE	18	23.430
		4 Gang Surround	KB_41_WE	18	37.070
KOTAK KONTAK TV, TELEPON DAN DATA		1 Gang Telepon Outlet Dengan Penutup	KB31TS	10	94.710
		2 Gang Telepon Outlet Dengan Penutup	KB32TS	10	98.890
		1 Gang Kotak Kontak TV	KB31TV-OS	10	100.650
		2 Gang Kotak Kontak TV	KB32TV	10	151.580
		1 Gang Kotak Kontak Data Cat 5E Dengan Penutup	KB31RJ5E	10	106.040
		1 Gang Kotak Kontak Data Cat 6	KB31RJ6-OS	10	137.390
		1 Gang Telp dengan penutup dan 1 Gang Data Cat 5E	KB32TS_RJ5E	10	188.870
PEREDUP LAMPU		400W 1 Gang Peredup Lampu (Dimmer)	KB31RD400_WE	8	289.520
FAN CONTROL		250VA 3 Gang Pengatur Kecepatan Kipas (Exhaust)	KB31RF250_WE	8	551.100
AKSESORI HOTEL		Hotel Key Card	KB31EKT	6	587.290
		Do Not Disturb & Clean Up Room dengan Bell Press	KB31BD_C_WE	8	140.250
		Do Not Disturb dengan Bell Press	KB31BD_WE	8	98.450
		115/240V Shaver Unit	KBT727V_WE	2	642.070



# S-Classic





















Desain Tak Lekang Waktu

- Dipercaya lebih dari 40 tahun
- Kuat, tahan banting

Clipsal telah diakuisisi oleh  
Schneider Electric di tahun 2007



# S-Classic

Jenis	Gambar	Keterangan	Referensi	Pak	Harga
SAKELAR		10AX Sakelar 1 Gang - 1 Arah	E31_1_2AR_WE_G3	10	23.870
		10AX Sakelar 1 Gang - 2 Arah	E31_2_3A_WE_G3	10	29.260
		10AX Sakelar 2 Gang - 1 Arah	E32_1_2AR_WE_G3	10	39.380
		10AX Sakelar 2 Gang - 2 Arah	E32_2_3A_WE_G3	10	46.970
		10AX Sakelar 3 Gang - 1 Arah	E33_1_2AR_WE_G3	10	57.200
		10AX Sakelar 3 Gang - 2 Arah	E33_2_3A_WE_G3	10	68.970
		10AX Sakelar 4 Gang - 1 Arah	E34_1_2AR_WE_G3	10	77.770
		10AX Sakelar 4 Gang - 2 Arah	E34_2_3A_WE_G3	10	90.970
		10AX Sakelar 5 Gang - 1 Arah	E35_1_2AR_WE_G3	10	116.820
		10AX Sakelar 5 Gang - 2 Arah	E35_2_3A_WE_G3	10	122.870
		10AX Sakelar 6 Gang - 1 Arah	ET36_1_2AR_WE	5	142.010
	10AX Sakelar Intermediate 1 Gang	E31IA_WE_G12	10	369.490	
		10AX 1 Gang Sakelar Bel	E31_1RBPRPA_WE	10	87.890
KOTAK KONTAK		16A 1 Gang Kotak Kontak Tipe Schuko	E426_16S_WE_G3	10	31.900
		13A 1 Gang Kotak Kontak dengan Sakelar dan Lampu Indikator Neon	E15NR_WE	10	72.160
		Tusuk kontak, Kotak Kontak 13A dengan Neon dan Outbowdoost	E15NR_EP13_E238_B	1	103.180
PLAT PENUTUP		1 Gang Plat Penutup	E31X	20	21.560
KOTAK KONTAK TV, TELEPON DAN DATA		1 Gang Kotak Kontak TV Koaksial, 75 Ohm	E31TV75_WE_G12	10	67.760
		1 Gang 4 Wire Telepon Outlet - Putih	ET01_4_WE	10	66.000
		2 Gang 4 Wire Telepon Outlet - Putih	ET02_4_WE	10	121.440
		1 Gang Kotak Kontak Data Cat 5	DCEKYBRWPS1PSWT_WE	10	91.520
		1 Gang Kotak Kontak Data RJ45	DC6KYBRWPS1PSWT_WE	10	95.040
PEREDUP LAMPU		500W Peredup Lampu (Dimmer)	E32V500_WE_G0	5	326.370
FAN CONTROL		400VA Pengatur Kecepatan Kipas (Exhaust)	E32V400F_WE_G12	5	747.010
AKSESORI HOTEL		Sakelar Kunci Hotel	E31KTU	6	172.920
		Key Tah (Pasangan E31KTU)	EKTU	300	25.850



# Kavacha

Perlindungan sepanjang waktu

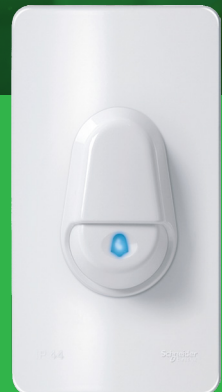





Kavacha bel pintu tahan cuaca, dengan proteksi IP 44, melindungi tamu Anda dari percikan air hujan

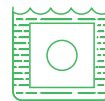

Jaga keluarga Anda dengan Kavacha pelindung sakelar dengan proteksi IP 55









Pastikan area basah di rumah Anda terhindar dari bahaya kesetrum, dengan Kavacha pelindung kontak kontak dengan proteksi IP 55



Perlindungan titik listrik di luar rumah Anda terhadap debu dan cuaca dengan Kavacha AS dan Kavacha Isolator Switch IP 56







# Kavacha

Gambar	Keterangan	Referensi	Pak	Harga
	Bel Pintu tahan cuaca dengan indikator LED, IP44, Putih	<b>A3031WBP_WE</b>	1	164.340
	220 V 2 - Wire Mechanical Door Chime	<b>99AC220 NEW</b>	1	159.280
	Pelindung kotak kontak tahan cuaca, IP55, Putih	<b>E223R_WE</b>	1	79.750
	Pelindung kotak kontak tahan cuaca, IP55, Transparan	<b>E223R_TR</b>	1	79.750
	20A 250V Surface Mount Single Pole Isolating Switch	<b>WHS20_GY</b>	1	399.630
	35A 250V Surface Mount Single Pole Isolating Switch	<b>WHS35_GY</b>	1	463.870
	55A 250V Surface Mount Single Pole Isolating Switch	<b>WHS55_GY</b>	1	469.810
	20A 440V Surface Mount Double Pole Isolating Switch	<b>WHD20_GY</b>	1	421.960
	35A 440V Surface Mount Double Pole Isolating Switch	<b>WHD35_GY</b>	1	463.210
	55A 440V Surface Mount Double Pole Isolating Switch	<b>WHD55_GY</b>	1	543.730
	63A 440V Surface Mount Double Pole Isolating Switch	<b>WHD63_GY</b>	1	581.130
	20A 440V Surface Mount Triple Pole Isolating Switch	<b>WHT20_GY</b>	1	443.630
	35A 440V Surface Mount Triple Pole Isolating Switch	<b>WHT35_GY</b>	1	510.950
	55A 440V Surface Mount Triple Pole Isolating Switch	<b>WHT55_GY</b>	1	634.150
	63A 440V Surface Mount Triple Pole Isolating Switch	<b>WHT63_GY</b>	1	670.890
	80A 440V Surface Mount Triple Pole Isolating Switch	<b>WHT80_GY</b>	1	790.790
	13A 250V Surface Mount Single Pole Switched Socket	<b>CSC313_GY</b>	1	571.120
	13A 250V Surface Mount Single Pole Switched Socket with Neon	<b>CSC313N_GY</b>	1	593.230

## Bel Pintu tahan cuaca dengan indikator LED



**A3031WBP\_WE**

-  Plat penutup polycarbonate yang rekat sehingga tidak meninggalkan celah untuk kebocoran.
-  Locator dengan LED biru yang tahan lama dan hemat energi, memberikan visibilitas yang lebih tinggi.
-  Penekan dolly besar yang mudah ditekan.
-  Desain paling tipis dan menarik.

# Kavacha Penutup Stop kontak Anti Air dengan Sertifikasi IP 55

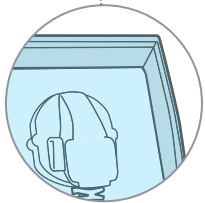

Penutup dengan desain cover yang transparan sehingga tidak mengganggu dekorasi rumah. Terbuat dari bahan polikarbonat yang tangguh dan tidak mudah pecah.

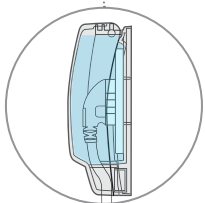

Penutup yang melengkung yang memberikan ruangan yang cukup untuk steker anda, sehingga dapat tetap melindungi titik Listrik Anda dari air dan debu walaupun dengan posisi steker terpasang di stop kontak.

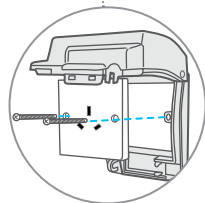

Cocok untuk Stop kontak dengan standar British (BS Standard dengan instalasi sekrup ukuran 86mm x 86mm). Pemasangan mudah dan cepat.

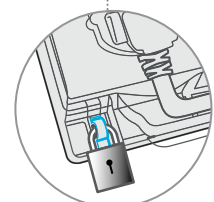

Tersedia pengait gembok untuk pengamanan tambahan.

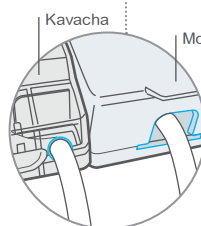

Model lainnya

Tersedia jalur kabel dengan ukuran presisi untuk melindungi dengan sempurna dari Air dan kelembapan bahkan dengan keadaan steker terpasang, Tidak seperti produk lain yang memberikan rongga cuku besar pada jalur kabelnya.



# ARGUS Occupancy Sensor

## Dual Teknologi

Gabungan teknologi Passive Infrared dan Ultrasonic memberikan efisiensi maksimum untuk berbagai aplikasi

## Peredupan Otomatis

Cahaya lampu dapat menyesuaikan tingkat terang/gelap cahaya berdasarkan pengaturan Lux (tingkat cahaya)



Deteksi  
Ultrasonik

+



Deteksi  
Infra Merah

=

0

Deteksi  
Tanpa Kesalahan

# Argus Occupancy Sensor

## Spesifikasi Produk

		Dual-technology sensing	Dual-technology sensing	High-frequency sensing
Referensi		CCT551011	CCT551012	CCT551023
Deskripsi		ARGUS Presence Dual-Tech (PIR & Ultrasonic) – 1 channel	ARGUS Presence Dual-Tech (PIR & Ultrasonic)- 2 channel	ARGUS High Bay Sensor (High Frequency) – 2 channel
Rentang Deteksi (Tinggi Instalasi: 2.5 m)		PIR: 8 m (diameter) US: adjustable up to 10 m x 16 m (oval shape)	PIR: 8 m (diameter) US: adjustable up to 10 m x 16 m (oval shape)	14 m (diameter) 10 m (diameter) at 6 – 10 m height
Beban 1 (Nilai Maksimal)	Lampu Pijar	2.000 W	2.000 W	2.000 W
	Lampu Holagen AC	1.000 W	1.000 W	1.000 W
	Lampu Holagen LV	1.000 VA	1.000 VA	1.000 VA
	Lampu TL	900 VA	900 VA	900 VA
	Lampu Hemat Energi (termasuk CFL dan Lampu PL)	80 VA	80 VA	80 VA
	Lampu LED	100 W	400 W	100 W
	Beban Kapasitif Jumlah maksimal ballast	100 µF	100 µF	100 µF
Beban 2 (Nilai Maksimal)	HVAC		5 A for ≤ 250 VAC, cos = 1 5 A for ≤ 30 VDC 1 A for ≤ 250 VAC, cos = 0,4	5 A for ≤ 250 VAC, cos = 1 5 A for ≤ 30 VDC 1 A for ≤ 250 VAC, cos = 0,4
Tegangan		230 VAC, 500 V 60 Hz	230 VAC, 500 V 60 Hz	230 VAC, 500 V 60 Hz
Harga		2.112.000	2.487.100	1.681.900

## Spesifikasi Produk

		Passive Infrared Sensing	Passive Infrared sensing
Referensi		CCT570005	CCT570003
Deskripsi		ARGUS Standard mini PIR Sensor	ARGUS Standard 2 Channel PIR Sensor
Rentang Deteksi (Tinggi Instalasi: 2.5 m)		6m (diameter))	7m (diameter)
Beban 1 (Nilai Maksimal)	Lampu Pijar	1.000 W	1.000 W
	Lampu Holagen AC	800 W	900 W
	Lampu Holagen LV	315 W	250 VA
	Lampu TL	250 VA	200 VA
	Lampu Hemat Energi (termasuk CFL dan Lampu PL)	80 VA	80 VA
	Lampu LED	100 W	100 W
	Beban Kapasitif Jumlah maksimal ballast	25 µF	14 µF (10 A)
Beban 2 (Nilai Maksimal)	HVAC	-	5 A for ≤ 250 VAC, cos = 1 5 A for ≤ 30 VDC 1 A for ≤ 250 VAC, cos = 0,4
Tegangan		230 VAC, 500 V 60 Hz	230 VAC, 50 Hz
Harga		960.190	1.013.320



# Neo

Sakelar dan kotak kontak horisontal dengan teknologi LED



## Inovasi desain yang Diakui dunia

NEO dengan desain inovatif telah diakui dunia dan memenangkan berbagai penghargaan internasional.

## Sakelar horisontal dengan LED *locator*

Dilengkapi dengan lampu LED agar lokasi sakelar mudah ditemukan dalam keadaan gelap.

## Kualitas & keamanan yang dirancang tahan lama

- Setiap bagian dilindungi oleh lapisan *polyurethane* untuk menjamin reabilitas produk.
- Terbuat dari material *polycarbonate* tahan **karat, panas, serta benturan**



Penggunaan penanda cahaya fluorescent white on white sebagai salah satu fitur eksklusif dari Neo.



# NEO Warna Putih (Body Putih, LED Putih)

Jenis	Gambar	Keterangan	Referensi	Pak	Harga
SAKELAR HORIZONTAL		10A 1 Gang 1 Arah Sakelar Horizontal, LED Putih	<b>E3031H1_EWWW_G3</b>	8	82.390
		10A 1 Gang 2 Arah Sakelar Horizontal, LED Putih	<b>E3031H2_EWWW_G3</b>	8	146.960
		10A 2 Gang 1 Arah Sakelar Horizontal, LED Putih	<b>E3032H1_EWWW_G3</b>	8	131.890
		10A 2 Gang 2 Arah Sakelar Horizontal, LED Putih	<b>E3032H2_EWWW_G3</b>	8	225.060
		10A 3 Gang 1 Arah Sakelar Horizontal, LED Putih	<b>E3033H1_EWWW_G3</b>	8	215.490
		10A 3 Gang 2 Arah Sakelar Horizontal, LED Putih	<b>E3033H2_EWWW_G3</b>	8	263.230
		10A 4 Gang 1 Arah Sakelar Horizontal, LED Putih	<b>E3034H1_EWWW_G3</b>	8	250.250
		10A 4 Gang 2 Arah Sakelar Horizontal, LED Putih	<b>E3034H2_EWWW_G3</b>	8	284.240
		4A 1 Gang Sakelar Bel Horizontal, LED Putih	<b>E3031HBP_WW</b>	8	282.920
	SAKELAR VERTIKAL		10A 1 Gang 1 Arah Sakelar Vertikal, LED Putih	<b>E3031V1_EWWW_G3</b>	8
		10A 1 Gang 2 Arah Sakelar Vertikal, LED Putih	<b>E3031V2_EWWW_G3</b>	8	146.960
		10A 2 Gang 1 Arah Sakelar Vertikal, LED Putih	<b>E3032V1_EWWW_G3</b>	8	131.890
		10A 2 Gang 2 Arah Sakelar Vertikal, LED Putih	<b>E3032V2_EWWW_G3</b>	8	225.060
		10A 3 Gang 1 Arah Sakelar Vertikal, LED Putih	<b>E3033V1_EWWW_G3</b>	8	215.490
		10A 3 Gang 2 Arah Sakelar Vertikal, LED Putih	<b>E3033V2_EWWW_G3</b>	8	263.230
		4A 1 Gang Sakelar Bel Vertikal, LED Putih	<b>E3031VBP_WW</b>	8	282.920
KOTAK KONTAK TV, TELEPON DAN DATA		16A 1 Gang Kotak Kontak Tipe Schuko, LED Putih	<b>E3426_16SS_WW_G3</b>	10	97.350
		10A 250V 1 Gang Kotak Kontak Internasional, LED Putih	<b>E3426_10IS_C15426</b>	8	199.320
		13A Kotak Kontak dengan Sakelar, Neon, LED Putih	<b>E3015D_EWWW</b>	8	235.950
		1 Gang Kotak Kontak Soket TV, 75 Ohm, Putih	<b>E3031TV_WW</b>	8	135.300
		1 Gang Kotak Kontak RJ11 4 Kawat Telepon Outlet, Putih	<b>E3031RJ_WW</b>	8	134.090
		1 Gang Kotak Kontak RJ45 Data Cat5E, Putih	<b>E3031RJ5E_WW</b>	8	135.960
USB CHARGER		1 x 2.1A USB Charger, WW	<b>E3031USB_WW</b>	8	641.190
		2 x 2.1A USB Charger, WW	<b>E3032USB_WW</b>	8	1.247.400
		International Socket + 2.1 A USB	<b>E342616USB_WW</b>	8	534.490
		USB Charger Type A + C QC - 21 W Max	<b>E3032ACQUSB_WW</b>	8	1.270.500
PLAT PENUTUP		1 Gang Plat Penutup, Putih	<b>E3030X_WW</b>	15	57.200
PEREDUP LAMPU		600W 1 Gang Sakelar Peredup Lampu (Dimmer), LED Putih	<b>E3031HD_EWWW</b>	8	1.168.200
AKSESORI HOTEL		E3000 KEY CARD SWITCH	<b>E3031EKTH_WW</b>	8	884.400
		1G Bell Push W/DO Not DIS & PLS Clean Up	<b>E3031VBPDM_WW</b>	8	462.990
		Do Not DIS.& PLS Clean Up Indicator	<b>E3030VDM_WW</b>	8	423.720
		Do Not DIS.& PLS Clean Up 2G Switch	<b>E3032HDM_WW</b>	8	523.490
		Shaver Unti Vertical, White	<b>ET3727V_WW</b>	1	1.071.950



# NEO Warna Grey Silver (Body Grey Silver, LED Biru)

Jenis	Gambar	Keterangan	Referensi	Pak	Harga
SAKELAR HORIZONTAL		10A 1 Gang 1 Arah Sakelar Horizontal, LED Biru, Grey Silver	E3031H1_EBGS_G3	8	121.110
		10A 1 Gang 2 Arah Sakelar Horizontal, LED Biru, Grey Silver	E3031H2_EBGS_G3	8	167.420
		10A 2 Gang 1 Arah Sakelar Horizontal, LED Biru, Grey Silver	E3032H1_EBGS_G3	8	151.800
		10A 2 Gang 2 Arah Sakelar Horizontal, LED Biru, Grey Silver	E3032H2_EBGS_G3	8	251.020
		10A 3 Gang 1 Arah Sakelar Horizontal, LED Biru, Grey Silver	E3033H1_EBGS_G3	8	247.500
		10A 3 Gang 2 Arah Sakelar Horizontal, LED Biru, Grey Silver	E3033H2_EBGS_G3	8	312.070
		10A 4 Gang 1 Arah Sakelar Horizontal, LED Biru, Grey Silver	E3034H1_EBGS_G3	8	275.330
		10A 4 Gang 2 Arah Sakelar Horizontal, LED Biru, Grey Silver	E3034H2_EBGS_G3	8	344.080
		4A 1 Gang Sakelar Bel Horizontal, Grey Silver	E3031HBP_GS	8	290.950
SAKELAR VERTIKAL		10A 1 Gang 1 Arah Sakelar Vertikal, LED Biru, Grey Silver	E3031V1_EBGS_G3	8	121.110
		10A 1 Gang 2 Arah Sakelar Vertikal, LED Biru, Grey Silver	E3031V2_EBGS_G3	8	167.420
		10A 2 Gang 1 Arah Sakelar Vertikal, LED Biru, Grey Silver	E3032V1_EBGS_G3	8	151.800
		10A 2 Gang 2 Arah Sakelar Vertikal, LED Biru, Grey Silver	E3032V2_EBGS_G3	8	251.020
		10A 3 Gang 1 Arah Sakelar Vertikal, LED Biru, Grey Silver	E3033V1_EBGS_G3	8	247.500
		10A 3 Gang 2 Arah Sakelar Vertikal, LED Biru, Grey Silver	E3033V2_EBGS_G3	8	312.070
		4A 1 Gang Sakelar Bel Vertikal, Grey Silver	E3031VBP_GS	8	290.950
KOTAK KONTAK TV, TELEPON DAN DATA		16A 1 Gang Kotak Kontak Tipe Schuko, Grey Silver	E3426_16SS_GS_G3	10	139.480
		10A 250V 1 Gang Kotak Kontak Internasional, Grey Silver	E3426_10IS_C15426A	8	204.710
		13A Kotak Kontak dengan Sakelar, Neon, Grey Silver	E3015D_EBGS	8	244.750
		1 Gang Kotak Kontak Soket TV, 75 Ohm, Grey Silver	E3031TV_GS	8	170.830
		1 Gang Kotak Kontak RJ11 4 Kawat Telepon Outlet, Grey Silver	E3031RJ_GS	8	153.120
		1 Gang Kotak Kontak RJ45 Data Cat5E, Grey Silver	E3031RJ5E_GS	8	141.460
USB CHARGER		1 x 2.1A USB Charger, GS	E3031USB_GS	8	684.640
		2 x 2.1A USB Charger, GS	E3032USB_GS	8	1.284.800
		International Socket + 2.1 A USB	E342616USB_GS	8	588.280
		USB Charger Type A + C QC - 21 W Max	E3032ACQUSB_GS	8	1.398.100
PLAT PENUTUP		1 Gang Plat Penutup, Grey Silver	E3030X_GS	15	72.270
PEREDUP LAMPU		600W 1 Gang Sakelar Peredup Lampu (Dimmer), LED Biru, GS	E3031HD_EBGS	8	1.173.700
AKSESORI HOTEL		E3000 KEY CARD SWITCH	E3031EKTH_GS	8	900.680
		1G BELL PUSH W/DO NOT DIS & PLS CLEAN UP	E3031VBPDM_GS	8	480.040
		DO NOT DIS. & PLS CLEAN UP INDICATOR	E3030VDM_GS	8	482.130
		DO NOT DIS. & PLS CLEAN UP 2G SWITCH	E3032HDM_GS	8	543.840
		SHAVER UNTI VERTICAL, Grey Silver	ET3727V_GS	1	1.148.840

# Mobiya

Lampu tenaga surya anti air dan tahan banting



## Anti Air

Dapat bertahan di dalam air dengan kedalaman 0.5 meter selama 1 (satu) jam (IP65)



## Tersedia Charger Smartphone

Memiliki kabel USB Charger untuk smartphone



## 3 Pilihan Kecerahan Cahaya Lampu LED

Tingkat kecerahan cahaya dapat disesuaikan, maksimal 170 lumens



## Dapat Bertahan Hingga 2 Hari

Dengan pengisian daya 1 hari penuh pada tingkat kecerahan cahaya terendah (20 lumens)



## Tahan Banting

Tidak mudah pecah

Referensi	Harga
AEP-LB01-SU12W	758.450

# Spesifikasi Mobiya AEP-LB01-SU12W

Panel surya - Wp2	2.5 Wp
Konsumsi daya oleh lampu LED	1.2 W
Tegangan input	5 V - 20 V $\pm$ 1V
Intensitas cahaya yang dihasilkan	170 Lumens
Durasi pencahayaan	<ul style="list-style-type: none"><li>• &gt; 6 jam: 170 Lumens</li><li>• &gt; 12 jam : 85 Lumens</li><li>• &gt; 48 jam: 20 Lumens</li></ul>
Panjang kabel	5m
Baterai	3.2 V, 3 Ah Lithium Ferro Phosphate
Port charger telepon selular	5 V, 400 mA +/-10 mA
Charging lampu dari port 5V USB	Yes
Sertifikasi	Lighting Global, SONCAP, IP65, LM79, CE and SABS (IEC Report)
Dimensi (Panjang x Lebar X Tinggi) mm	Lampu: 156 x 156 x 142 / Panel: 192 x 185 x 196
Berat kotor	1.3 kg



CC Domae  
pilihan terbaik.

Pastikan rumah Anda terlindungi  
oleh perangkat proteksi arus listrik  
yang berkualitas



MCB

RCBO

RCCB

SPD

# MCB Domae

MCB 1 POLE



Rating Arus

2 - 63A

MCB 2 POLE



Rating Arus

2 - 63A

MCB 3 POLE



Rating Arus

6 - 63A

## MCB | Melindungi dari:



Beban berlebih



Hubung singkat  
atau korsleting



### Breaking Capacity **6.000A (6kA)**

Pada saat terjadi arus pendek (korsleting), arus akan melonjak sangat tinggi. MCB Domae mampu menahan korsleting hingga 6.000A



### Daya tahan mekanikal **20.000 kali**

MCB Domae Baru memiliki daya tahan mekanikal, atau daya tahan MCB untuk dioperasikan on dan off (toggle klak-klik naik dan turun) TANPA aliran listrik, sebesar 20.000 kali

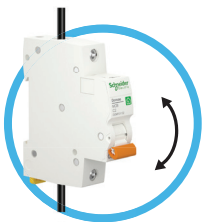

### Daya tahan elektrik **10.000 kali**

MCB Domae Baru memiliki daya tahan elektrik, atau daya tahan MCB untuk dioperasikan on dan off (toggle klak-klik naik dan turun) DENGAN aliran listrik, sebesar 10.000 kali



MCB Domae sudah bersertifikat **SNI**

# RCCB Domae

Pastikan rumah Anda terlindungi dari kesetrum dengan menggunakan RCCB Domae

RCCB Domae adalah perangkat listrik yang mampu mencegah terjadinya kesetrum terhadap penghuni rumah. Kemampuannya mendeteksi dan mencegah terjadinya kesetrum memberikan rasa aman bagi kita.

### CATATAN:

Beberapa tukang listrik mengenal produk ini sebagai ELCB.



- RCCB Domae sensitivitas 30mA untuk perlindungan manusia, sensitivitas 300mA untuk perlindungan aset atau mesin
- Pastikan bahwa instalasi listrik rumah Anda sudah terpasang grounding
- Setelah selesai instalasi RCCB Domae, jangan lupa untuk menekan tombol test untuk memeriksa apakah RCCB Domae berfungsi dengan baik.
- Jika setelah di tekan tombol test, tuas/toggle yang berwarna Oranye turun (off), maka RCCB Domae berfungsi dengan baik. Naikkan kembali tuas/toggle ke arah atas (on)

## Petunjuk Instalasi RCCB Domae

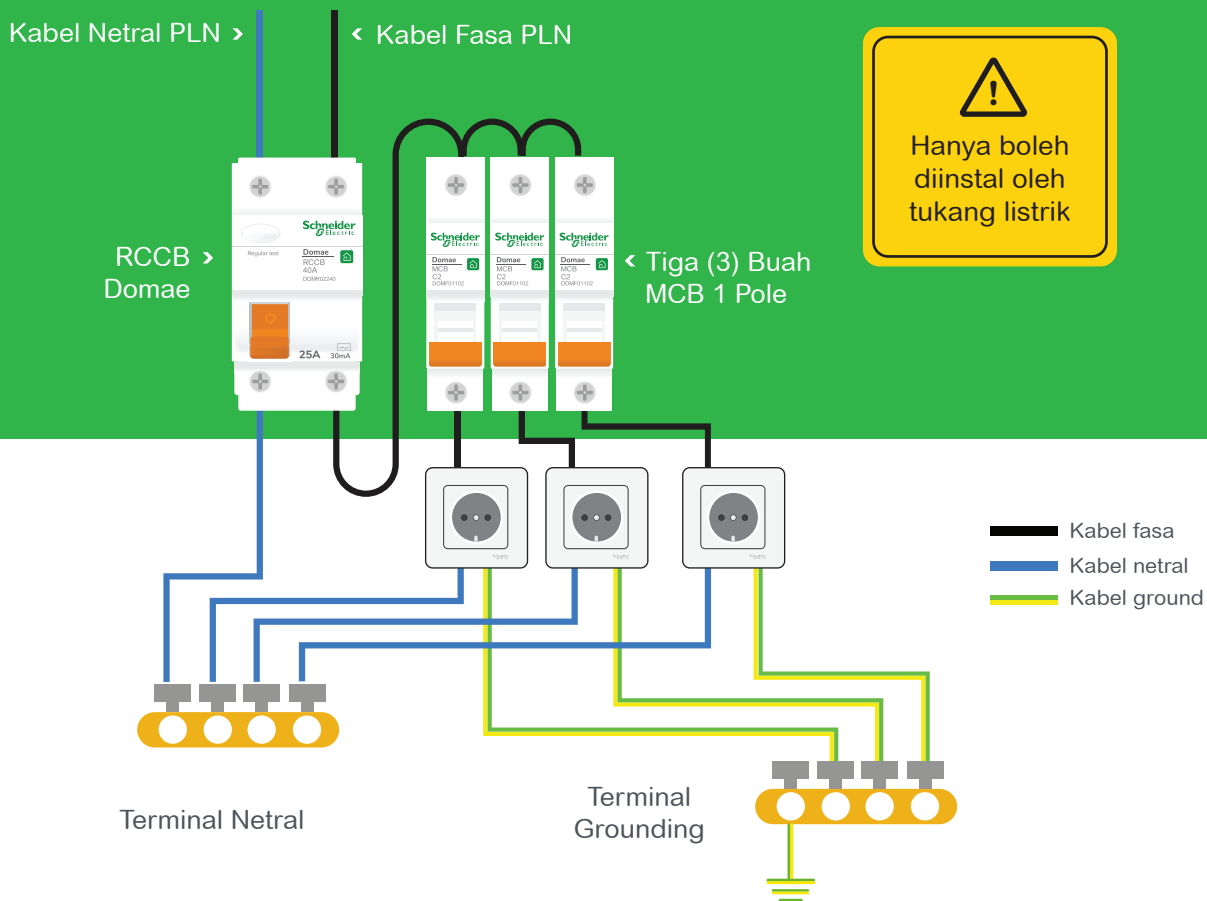

# RCBO Slim Domae



RCBO Slim Domae adalah inovasi yang merupakan gabungan Antara MCB dengan RCCB.

## Fungsi RCBO Slim Domae



Melindungi dari kesetrum



Melindungi dari korsleting (short circuit)



Melindungi dari beban lebih

# Surge arrester (SPD Domae)



Surge Arrester (SPD) Domae adalah perangkat listrik yang melindungi peralatan elektronik terhadap bahaya induksi petir.

## Fungsi SPD Domae



Melindungi peralatan elektronik dari bahaya induksi petir

## Petunjuk Instalasi RCBO Slim dan SPD Domae

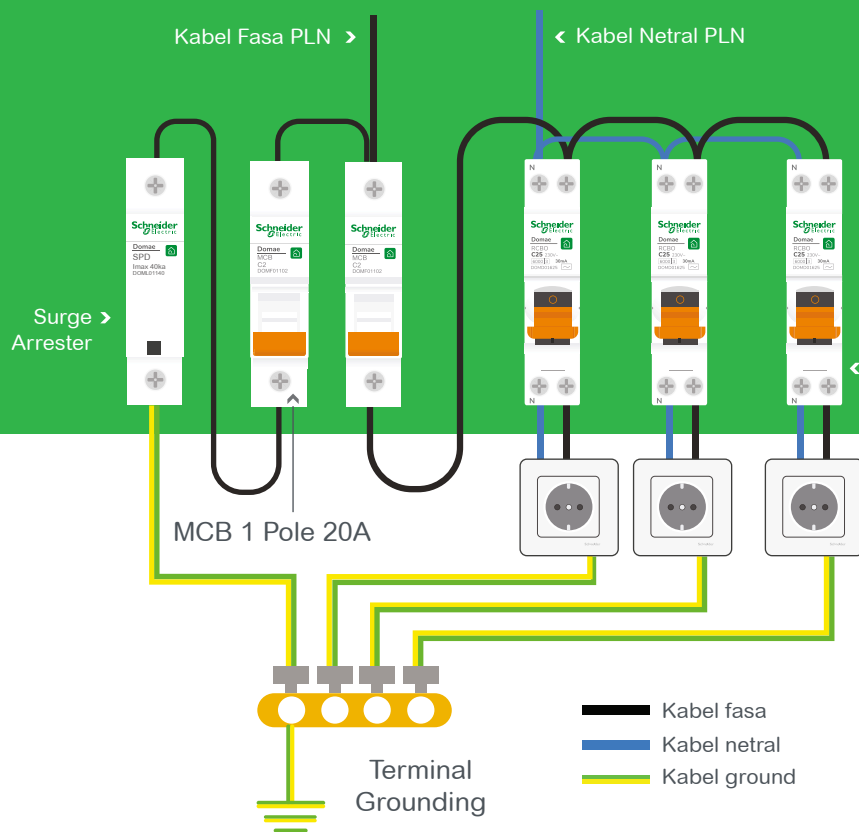

### CATATAN:



Rangkaian ini adalah simulasi instalasi RCBO Slim dan SPD Domae pada satu rangkaian.

1. Untuk instalasi RCBO Slim Domae saja, hilangkan SPD Domae dan MCB Domae 20A
2. Untuk instalasi SPD dan MCB Domae saja, gantikan 3 RCBO Slim Domae dengan 3 MCB Domae.

< Tiga (3) Buah RCBO Slim Domae



## MCB Domae



Gambar	Kutub	Rating Arus	Referensi	Pak	Harga
	1	2	DOMF01102	12	92.290
		4	DOMF01104	12	92.290
		6	DOMF01106	12	73.810
		10	DOMF01110	12	73.810
		16	DOMF01116	12	73.810
		20	DOMF01120	12	73.810
		25	DOMF01125	12	81.950
		32	DOMF01132	12	85.690
		40	DOMF01140	12	103.290
		50	DOMF01150	12	218.240
	2	63	DOMF01163	12	218.240
		2	DOMF01202	6	273.570
		4	DOMF01204	6	273.570
		6	DOMF01206	6	210.320
		10	DOMF01210	6	210.320
		16	DOMF01216	6	210.320
		20	DOMF01220	6	210.320
		25	DOMF01225	6	239.140
		32	DOMF01232	6	247.500
		40	DOMF01240	6	294.470
	3	63	DOMF01263	6	483.670
		6	DOMF01306	6	340.780
		10	DOMF01310	4	340.780
		16	DOMF01316	4	340.780
		20	DOMF01320	4	340.780
		25	DOMF01325	4	365.420
		32	DOMF01332	4	395.780
		40	DOMF01340	4	464.860
		50	DOMF01350	4	772.310
		63	DOMF01363	4	772.310

## MCB Box

Gambar	Modul	Tinggi	Lebar	Tebal	Referensi	Harga
	4	222	136	92	DOMH12104F	95.370
	8	222	208	92	DOMH12108F	136.180
	12	222	280	92	DOMH12112F	174.350



## RCBO Slim & ELCB Domae

Gambar	Kutub	Sensitivitas	Rating Arus	Referensi	Pak	Harga
<b>RCBO Slim</b>						
	1P + N	30 mA	6	<b>DOMD01606</b>	12	637.120
			10	<b>DOMD01610</b>	12	637.120
			16	<b>DOMD01616</b>	12	637.120
			20	<b>DOMD01620</b>	12	637.120
			25	<b>DOMD01625</b>	12	700.920
<b>ELCB</b>						
	1P + N	30 mA	25	<b>DOMR01225</b>	6	573.980
			40	<b>DOMR01240</b>	6	631.290
			63	<b>DOMR01263</b>	6	821.920
		300 mA	25	<b>DOMR02225</b>	6	602.690
			40	<b>DOMR02240</b>	6	662.970
			63	<b>DOMR02263</b>	6	849.750
	3P + N	30 mA	25	<b>DOMR01425</b>	3	874.060
			40	<b>DOMR01440</b>	3	951.610
			63	<b>DOMR01463</b>	3	1.283.480
		300 mA	25	<b>DOMR02425</b>	3	903.980
			40	<b>DOMR02440</b>	3	1.044.120
			63	<b>DOMR02463</b>	3	1.294.590

## Surge Arrester

Gambar	Tipe	Referensi	Pak	Harga
<b>Surge Arrester PF 40kA</b>				
	Domae PF 1P	<b>DOML01140</b>	12	296.010
	Domae PF 1P+N	<b>DOML01640</b>	6	675.510
	Domae PF 3P	<b>DOML01340</b>	3	948.310
	Domae PF 3P+N	<b>DOML01740</b>	3	1.221.440

## Mini Pragma

Gambar	Baris	Modul (18mm)	Tinggi	Lebar	Tebal	Referensi	Harga
<b>Transparan (Inbow)</b>							
	1	8	252	222	98	<b>MIP22108S</b>	582.670
	1	12	252	294	98	<b>MIP22112S</b>	497.200
	1	18	252	402	98	<b>MIP22118S</b>	561.550
	2	24	377	294	98	<b>MIP22212S</b>	639.540
	3	36	502	294	98	<b>MIP22312S</b>	937.310
<b>Putih (Inbow)</b>							
	1	8	252	222	98	<b>MIP22108</b>	380.710
	1	12	252	294	98	<b>MIP22112</b>	451.990
	1	18	252	402	98	<b>MIP22118</b>	564.740
	2	24	377	294	98	<b>MIP22212</b>	606.540
	3	36	502	294	98	<b>MIP22312</b>	827.090

# EasyPact CVS 100/160/250 dengan TMD

Fixed type, front connection.

Memenuhi standar IEC 60947.2.

Arus Nominal (In) : 100 A/160 A/250 A

Kapasitas Pemutusan : B (25), F(36) kA pada 380/415 VAC

Ics : 100% Icu.

Trip unit : TMD: Thermal Magnetic (adjustable 0.7 1 x In), untuk proteksi beban distribusi.

## EasyPact CVS100-250 B & F

Trip Unit	Ir (A)	Im (A)	3P	Harga	4P	Harga
<b>EasyPact CVS100-250 B (25 kA)</b>						
TM16D	11.2-16	190	<b>LV510300</b>	1.314.500	<b>LV510310</b>	1.721.500
TM25D	17.5-25	300	<b>LV510301</b>	1.314.500	<b>LV510311</b>	1.721.500
TM32D	22.4-32	400	<b>LV510302</b>	1.314.500	<b>LV510312</b>	1.721.500
TM40D	28-40	500	<b>LV510303</b>	1.314.500	<b>LV510313</b>	1.721.500
TM50D	35-50	500	<b>LV510304</b>	1.314.500	<b>LV510314</b>	1.721.500
TM63D	44.1-63	500	<b>LV510305</b>	1.314.500	<b>LV510315</b>	1.871.100
TM80D	56-80	640	<b>LV510306</b>	1.314.500	<b>LV510316</b>	1.871.100
TM100D	70-100	800	<b>LV510307</b>	1.314.500	<b>LV510317</b>	1.871.100
TM125D	87.5-125	1250	<b>LV516302</b>	1.882.100	<b>LV516312</b>	2.450.800
TM160D	112-160	1250	<b>LV516303</b>	2.186.800	<b>LV516313</b>	2.844.600
TM200D	140-200	2000	<b>LV525302</b>	2.446.400	<b>LV525312</b>	3.069.000
TM250D	175-250	2500	<b>LV525303</b>	2.516.800	<b>LV525313</b>	3.159.200
<b>EasyPact CVS100-250 F (36 kA)</b>						
TM16D	11.2-16	190	<b>LV510330</b>	1.427.800	<b>LV510340</b>	1.895.300
TM25D	17.5-25	300	<b>LV510331</b>	1.427.800	<b>LV510341</b>	1.895.300
TM32D	22.4-32	400	<b>LV510332</b>	1.427.800	<b>LV510342</b>	1.895.300
TM40D	28-40	500	<b>LV510333</b>	1.427.800	<b>LV510343</b>	1.895.300
TM50D	35-50	500	<b>LV510334</b>	1.427.800	<b>LV510344</b>	1.895.300
TM63D	44.1-63	500	<b>LV510335</b>	1.446.500	<b>LV510345</b>	1.950.300
TM80D	56-80	640	<b>LV510336</b>	1.446.500	<b>LV510346</b>	1.950.300
TM100D	70-100	800	<b>LV510337</b>	1.446.500	<b>LV510347</b>	1.950.300
TM125D	87.5-125	1250	<b>LV516332</b>	2.071.300	<b>LV516342</b>	2.505.800
TM160D	112-160	1250	<b>LV516333</b>	2.475.000	<b>LV516343</b>	2.968.900
TM200D	140-200	2000	<b>LV525332</b>	3.115.200	<b>LV525342</b>	3.908.300
TM250D	175-250	2500	<b>LV525333</b>	3.208.700	<b>LV525343</b>	4.028.200



## Kontak Bantu CVS100-250

Tipe	Referensi	Harga
OF/SD/SDE/SDV	<b>29450</b>	485.100
Adaptor SDE untuk trip unit TM / MA / ETS2.3 (harus diorder bersama SDE ref. 29450)	<b>LV429451</b>	199.100

## Voltage Release

Tegangan Kontrol	MX	Harga	MN	Harga
110/130	<b>LV429386</b>	1.218.800	<b>LV429406</b>	1.624.700
AC 200/240	<b>LV429387</b>	1.218.800	<b>LV429407</b>	1.624.700
380/415 (50 Hz)	<b>LV429388</b>	1.218.800	<b>LV429408</b>	1.624.700
12	<b>LV429382</b>	1.218.800	<b>LV429402</b>	1.624.700
24	<b>LV429390</b>	1.218.800	<b>LV429410</b>	1.624.700
DC 30	<b>LV429391</b>	1.218.800	<b>LV429411</b>	1.624.700
48	<b>LV429392</b>	1.218.800	<b>LV429412</b>	1.624.700
125	<b>LV429393</b>	1.218.800	<b>LV429413</b>	1.624.700
250	<b>LV429394</b>	1.218.800	<b>LV429414</b>	1.624.700
MN 48 VAC dengan tunda waktu (untuk MN 48 V DC LV429412)			<b>LV429426</b>	3.698.200
MN 220/240 VAC dengan tunda waktu (untuk MN 250 V DC LV429414)			<b>LV429427</b>	3.698.200



Catatan: Ics = Service Breaking Capacity, Icu = Ultimate Breaking Capacity.

# EasyPact EZC 100-250A



EasyPact	I <sub>r</sub> (A)	3P	Harga
<b>EasyPact EZC100B (7.5 kA @415V AC)</b>			
EZC100B	15	<b>EZC100B3015</b>	744.700
EZC100B	20	<b>EZC100B3020</b>	744.700
EZC100B	25	<b>EZC100B3025</b>	744.700
EZC100B	30	<b>EZC100B3030</b>	744.700
EZC100B	40	<b>EZC100B3040</b>	744.700
EZC100B	50	<b>EZC100B3050</b>	744.700
EZC100B	60	<b>EZC100B3060</b>	789.800
<b>EasyPact EZC100F (10 kA @415V AC)</b>			
EZC100F	15	<b>EZC100F3015</b>	796.400
EZC100F	20	<b>EZC100F3020</b>	796.400
EZC100F	25	<b>EZC100F3025</b>	796.400
EZC100F	30	<b>EZC100F3030</b>	796.400
EZC100F	40	<b>EZC100F3040</b>	796.400
EZC100F	50	<b>EZC100F3050</b>	796.400
EZC100F	60	<b>EZC100F3060</b>	854.700
EZC100F	75	<b>EZC100F3075</b>	854.700
EZC100F	80	<b>EZC100F3080</b>	854.700
EZC100F	100	<b>EZC100F3100</b>	854.700
<b>EasyPact EZC250F (18 kA @415V AC / 5 kA @125V DC; 250V DC)</b>			
EZC250F	100	<b>EZC250F3100</b>	1.670.900
EZC250F	125	<b>EZC250F3125</b>	1.710.500
EZC250F	160	<b>EZC250F3160</b>	1.778.700
EZC250F	200	<b>EZC250F3200</b>	1.905.200
EZC250F	225	<b>EZC250F3225</b>	1.905.200
EZC250F	250	<b>EZC250F3250</b>	1.905.200

## Kontak Bantu & Voltage Release

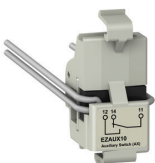

Deskripsi	Referensi EZC100	Harga	Referensi EZC250	Harga
<b>Kontak Bantu</b>				
Auxiliary Switch (AX)	<b>EZAUX10</b>	321.200	<b>EZEAX</b>	394.900
Alarm Switch (AL)	<b>EZAUX01</b>	392.700	<b>EZEAL</b>	479.600
Auxiliary Switch/ Alarm Switch (AX/AL)	<b>EZAUX11</b>	641.300	<b>EZEAXAL</b>	784.300
<b>Voltage Release</b>				
Shunt Trip	100-130 VAC	<b>EZASHT100AC</b>	-	-
	200-277 VAC	<b>EZASHT200AC</b>	<b>EZESHT200AC</b>	856.900
	380-480 VAC	<b>EZASHT380AC</b>	<b>EZESHT400AC</b>	856.900
	24 VDC	<b>EZASHT024DC</b>	-	-
Under Voltage Release (UVR)	110-130 VAC	<b>EZAUVR200AC</b>	<b>EZEUVRN110AC</b>	3.498.000
	200-240 VAC	<b>EZAUVR380AC</b>	-	-
	24 VDC	<b>EZAUVR024DC</b>	<b>EZEUVRN024DC</b>	3.498.000



# Industrial plug socket

Performa tinggi sesuai dengan standar IEC serta mudah diinstal

## Plug & Socket

Gambar	Arus Pengenal	Jumlah Kutub	Tegangan Pengenal	Warna	Referensi	Harga
 <p>Wall Mounted Socket IP 44</p>	16 A	2P + Pe	200 - 250V	Biru	<b>83104</b>	224.070
		3P + Pe	380 - 415V	Merah	<b>83108</b>	296.450
		3P + N + Pe	380 - 415V	Merah	<b>83109</b>	408.320
	32 A	2P + Pe	200 - 250V	Biru	<b>83116</b>	355.960
		3P + Pe	380 - 415V	Merah	<b>83120</b>	434.060
		3P + N + Pe	380 - 415V	Merah	<b>83121</b>	434.060

Gambar	Arus Pengenal	Jumlah Kutub	Tegangan Pengenal	Referensi	Pak	Harga
<b>Socket Panel IP67</b>						
	16 A	2P + Pe	200 - 250V	<b>PKF16F723</b>	10	239.690
		3P + Pe	380 - 415V	<b>PKF16F734</b>	10	273.900
		3P + N + Pe	380 - 415V	<b>PKF16F735</b>	10	299.420
	32 A	2P + Pe	200 - 250V	<b>PKF32F723</b>	8	353.760
		3P + Pe	380 - 415V	<b>PKF32F734</b>	8	374.440
		3P + N + Pe	380 - 415V	<b>PKF32F735</b>	7	408.980

### Plug Wander IP44

	16 A	2P + Pe	200 - 250V	<b>PKE16M423</b>	10	130.790
		3P + Pe	380 - 415V	<b>PKE16M434</b>	10	144.320
		3P + N + Pe	380 - 415V	<b>PKE16M435</b>	10	177.540
	32 A	2P + Pe	200 - 250V	<b>PKE32M423</b>	10	193.160
		3P + Pe	380 - 415V	<b>PKE32M434</b>	10	203.170
		3P + N + Pe	380 - 415V	<b>PKE32M435</b>	10	233.530

### Socket Wander IP44

	16 A	2P + Pe	200 - 250V	<b>PKF16M423</b>	10	191.400
		3P + Pe	380 - 415V	<b>PKF16M434</b>	10	207.570
		3P + N + Pe	380 - 415V	<b>PKF16M435</b>	10	235.840
	32 A	2P + Pe	200 - 250V	<b>PKF32M423</b>	10	256.740
		3P + Pe	380 - 415V	<b>PKF32M434</b>	10	258.830
		3P + N + Pe	380 - 415V	<b>PKF32M435</b>	8	310.530

## IP 67

Gambar	Arus Pengenal	Jumlah Kutub	Tegangan Pengenal	Warna	Referensi	Harga
 <p>Mobile Plug IP 67</p>	16 A	2P + Pe	200 - 250V	Biru	<b>PKE16M723</b>	261.030
		3P + Pe	380 - 415V	Merah	<b>PKE16M734</b>	283.360
		3P + N + Pe	380 - 415V	Merah	<b>PKE16M735</b>	290.620
	32 A	2P + P	200 - 250V	Biru	<b>PKE32M723</b>	347.930
		3P + Pe	380 - 415V	Merah	<b>PKE32M734</b>	380.930
		3P + N + Pe	380 - 415V	Merah	<b>PKE32M735</b>	408.980

## Sakelar S56

Gambar	Arus Pengenal	Jumlah Sakelar	Tegangan Pengenal	Referensi	Pak	Harga
	10	1	250	S56SW110GY	24	403.590
	20	1	250	S56SW120GY	24	449.790
	32	1	250	S56SW132GY	24	513.370
	20	2	500	S56SW220GY	24	799.040
	10	3	500	S56SW310GY	24	583.440
	20	3	500	S56SW320GY	24	602.360



# EasyPact™ TVS

Kontaktor dengan kemampuan beroperasi 1,4 juta kali

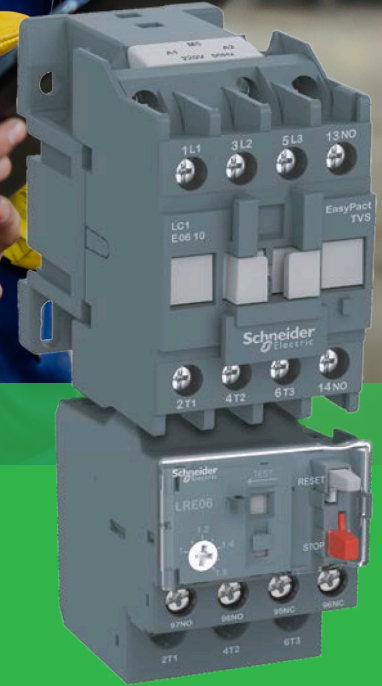

# Kontaktor 3 Kutub - EasyPact TVS

AC1 (A)	AC3 380/400 V (kW)	AC3 (A)	Kontak Bantu		Referensi	Harga (Rp)	SS
			N/O	N/C			
<b>Koneksi Standard</b>							
20	2.2	6	1	0	LC1E0610M7	202.400	1
20	2.2	6	0	1	LC1E0601M7	202.400	1
25	4	9	1	0	LC1E0910M7	222.200	1
25	4	9	0	1	LC1E0901M7	222.200	1
25	5.5	12	1	0	LC1E1210M7	243.100	1
25	5.5	12	0	1	LC1E1201M7	243.100	1
32	7.5	18	1	0	LC1E1810M7	332.200	1
32	7.5	18	0	1	LC1E1801M7	332.200	1
36	11	25	1	0	LC1E2510M7	429.000	1
36	11	25	0	1	LC1E2501M7	429.000	1
50	15	32	1	0	LC1E3210M7	601.700	1
50	15	32	0	1	LC1E3201M7	601.700	1
50	18.5	38	1	0	LC1E3810M7	742.500	1
50	18.5	38	0	1	LC1E3801M7	742.500	1
60	18.5	40	1	1	LC1E40M7	1.009.800	1
70	22	50	1	1	LC1E50M7	1.145.100	1
80	30	65	1	1	LC1E65M7	1.685.200	1
110	37	80	1	1	LC1E80M7	1.805.100	1
120	45	95	1	1	LC1E95M7	2.181.300	1
150	55	120	1	1	LC1E120M5	2.827.000	1
200	75	160	1	1	LC1E160M5	3.742.200	1
250	90	200	-	-	LC1E200M5	7.056.500	1
300	132	250	-	-	LC1E250M5	8.153.200	1
320	160	300	-	-	LC1E300M5	17.262.300	1
500	200	400	-	-	LC1E400M7	22.115.500	1
700	250	500	-	-	LC1E500M7	26.731.100	1
1000	335	630	-	-	LC1E630M7	26.782.800	1



**Catatan:**

Coil M7 ataupun M5 adalah untuk aplikasi pada 220 V AC. Untuk tipe tegangan coil lainnya silakan hubungi Customer Care Center kami.

# Kontaktor 3 Kutub - TeSys D

AC1(A)	AC-3 380/415 V		Kontak Bantu		Referensi	Harga	
	400 V (kW)	415 V (kW)	N/O	N/C		Koil AC	Koil DC
<b>Koneksi Standar</b>							
25	4	9	1	1	LC1D09●●	303.600	891.000
25	5.5	12	1	1	LC1D12●●	358.600	951.500
32	7.5	18	1	1	LC1D18●●	469.700	1.273.800
40	11	25	1	1	LC1D25●●	635.800	1.721.500
50	15	32	1	1	LC1D32●●	865.700	2.488.200
50	18.5	38	1	1	LC1D38●●	1.065.900	2.648.800
<b>Koneksi Everlink</b>							
60	18.5	40	1	1	LC1D40A●●	1.482.800	3.534.300
80	22	50	1	1	LC1D50A●●	1.786.400	3.740.000
80	30	65	1	1	LC1D65A●●	2.494.800	4.050.200

**Catatan:** Gantikan kode ●● pada referensi untuk tegangan kontrol koil sesuai dengan tabel dibawah.

Koil	220 V AC	24 V AC
Kode	M7	BD





# PowerLogic

Power Meter yang  
Lengkap dan Andal





# PowerLogic DM Series & EasyLogic PM2000

## Data Teknis

Kelas akurasi	: 0.5 untuk Tegangan dan Arus, 0.2 untuk Frekuensi
Standard	: IEC6100042, IEC6100044, IEC6100045, dan IEC60060
Display	: 4 digit LED
Suhu operasi	: 10 C s/d 60 C
Dimensi	: 96 x 96, cutout 92X92
Ratio CT & PT	: Adjustable



Fasa	Pengukuran	Operating Range	Referensi	Harga
1	Ampere Meter	50mA-6A	<b>METSEDM1110</b>	484.000
1	Volt Meter	44-480 VAC	<b>METSEDM1210</b>	475.200
1	Frequency Meter	20-100 Hz	<b>METSEDM1310</b>	684.200
3	Ampere Meter	50mA-6A	<b>METSEDM3110</b>	592.900
3	Volt Meter	80-480 VAC L-L	<b>METSEDM3210</b>	547.800

## Spesifikasi Umum Power Meter

- Mengukur parameter kelistrikan standar (arus, tegangan, frekuensi, faktor daya, daya, dan energi), dengan kelas akurasi yang baik
- Dilengkapi dengan display LED atau LCD untuk memudahkan pembacaan
- Dimensi : 96 x 96, cutout : 92 x 92
- Adjustable CT & PT Ratio

Spesifikasi	DM6200H	PM2120	PM2220	PM2230
<b>Pengukuran</b>				
• Arus (Fasa dan Netral)	√	√	√	√
• Tegangan (Rata-rata, Fasa-Fasa, dan Fasa-Netral)	√	√	√	√
• Frekuensi	√	√	√	√
• Faktor Daya (Rata-rata dan per Fasa)	√	√	√	√
• Daya (Total dan per Fasa)		√	√	√
• Energi (Aktif, Reaktif, Nyata)		√	√	√
• THD (Arus dan Tegangan)		√	√	√
<b>Kelas Akurasi</b>				
Arus	1	0.5	0.5	0.5
Tegangan	1	0.5	0.5	0.5
Daya Aktif		0.5	0.5	0.5
Daya Reaktif		1	1	1
Energi Aktif		1	1	0.5S
Energi Reaktif		1	1	1
<b>Spesifikasi Lainnya</b>				
LCD	LED 7segment	LED 7segment	Monochrome	Monochrome
Resolusi LCD	-	-	128 x 128	128 x 128
Modbus Serial (RS485)	√	√	√	√

Spesifikasi	Referensi	Harga
Digital Meter Seri 6000H dengan komunikasi	<b>METSEDM6200HCL10RS</b>	1.665.400
Power Meter Seri 2000 LED dengan Komunikasi	<b>METSEPM2120</b>	3.462.800
Power Meter Seri 2000 LCD dengan komunikasi	<b>METSEPM2220</b>	5.335.000
Power Meter Seri 2000 LCD dengan Komunikasi dan Akurasi 0.5S	<b>METSEPM2230</b>	5.646.300

# Harmony Push Button dan Signaling

Push Button tahan hingga  
**10 juta** kali klik



Produk Relay Schneider memiliki ketahanan mekanis hingga **100 ribu** kali cycle, serta dilengkapi dengan tombol tes manual dan lampu status LED

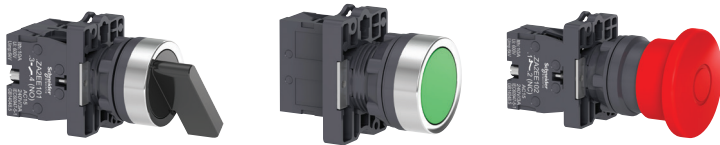

## Harmony XB5



- Kualitas standar internasional, indeks proteksi yang tinggi mencapai IP66.
- Sertifikasi lengkap antara lain : IEC, UL, CE, CSA, CCC, NEMA, BV, RINA, GL, dan lain-lain.
- 100.000 jam operasional untuk pilot light dan 10.000.000 kali durabilitas mekanik push button
- Pemasangan yang mudah dan klip metal memastikan push button tidak mudah terlepas.

### Harmony XB5, Diameter 22 mm, IP66

Produk	Referensi	Keterangan	Warna	Harga
Push Button	XB5AA●●	1 N/O (1 N/C untuk merah)	Hitam(21), Hijau(31), Merah(42), Kuning(51), Biru(61)	71.500
Pilot Light	XB5AVM●	230...240V AC	Putih(1), Hijau(3), Merah(4), Jingga(5), Biru(6)	101.200
Selector Switch	XB5AD21	2 Posisi - 1 N/O	Hitam	114.400
Emergency Stop	XB5AS8442	Latching Turn To Release Ø40 mm - 1 N/C	Merah	146.300

**Catatan:** Gantikan kode ●● dan ● pada referensi dengan kode warna.

## Harmony XA2

### Kualitas Produk yang OK dengan harga yang Pas

- Performa produk yang dapat diandalkan, IP54 untuk push button dan IP40 untuk pilot light
- Ketahanan dan kualitas yang teruji, standar internasional IEC dan CCC

### Mudah dipilih, Mudah digunakan

- Fungsi-fungsi dasar sesuai kebutuhan aplikasi
- Pemasangan yang mudah dan cepat, push button bisa ditambahkan kontak N/O atau N/C

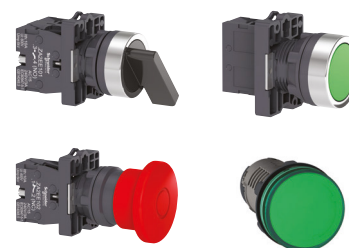

### Harmony XA2, Diameter 22 mm, IP54 & IP40

Produk	Referensi	Keterangan	Warna	Harga
Push Button	XA2EA●●	1 N/O (1 N/C untuk merah)	Putih(11), Hitam(21), Hijau(31), Merah(42), Jingga(51), Biru(61)	38.500
Pilot Light	XA2EVM●LC	220V AC	Putih(1), Hijau(3), Merah(4), Jingga(5), Biru(6)	30.800
Selector Switch	XA2ED21	2 Posisi - 1 N/O	Hitam	51.700
Emergency Stop	XA2ES542	Turn To Release Ø40 mm - 1 N/C	Merah	70.400

**Catatan:** Gantikan kode ●● dan ● pada referensi dengan kode warna.

# ABL2 Switch Mode Power Supplies

- 100 .... 240 input VAC, satu fasa
- Output 24VDC
- 7 opsi daya dalam kisaran 35-350 W
- Rangkaian lengkap sesuai dengan standar EMC
- Sesuai dengan standar CE dan RoHS
- Tegangan output, +/- 10% dapat disesuaikan
- Indikator LED hijau di terminal output
- Produk ini dilengkapi dengan penutup pelindung plastik untuk terminal block sebagai standar.
- Lubang pemasangan yang mudah
- Pemilihan voltase input 115 / 230V AC
- Adaptasi otomatis untuk model 35 / 50W
- Manual dengan sakelar untuk model 100-350W



Tegangan Input (V)	Tegangan Output (V DC)	Daya Nominal (Watt)	Arus Nominal (A)	Filter	Referensi	Harga
<b>Single-phase (N-L1) atau phase-to-phase (L1-L2)</b>						
AC 100...240 (1) single-phase wide range AC 100...120 AC 200...240 (2) single-phase	24 VDC	35 watt	1.5	Automatic	<b>ABL2REM24015K</b>	363.000
		50 watt	2.2	Automatic	<b>ABL2REM24020K</b>	404.800
		100 watt	4.5	Manual	<b>ABL2REM24045K</b>	532.400
	24 VDC	150 watt	6.5	Manual	<b>ABL2REM24065K</b>	601.700
		200 watt	8.3	Manual	<b>ABL2REM24085K</b>	851.400
		250 watt	10.5	Manual	<b>ABL2REM24100K</b>	973.500
		350 watt	14.6	Manual	<b>ABL2REM24150K</b>	1.026.300

## Aksesori Mounting

Deskripsi	Untuk Power Supply	Pak	Referensi	Harga
Braket Instalasi empat pojokan	Direkomendasikan untuk Baut M4*6mm atau M4*8mm	40	<b>ABL2K01</b>	Hub. Kami
35MM Braket utk DIN Rail 35mm	ABL2REM24085K/100K/150K: tiap produk butuh 4 ABL2REM24200K/250K/350K butuh 2	5	<b>ABL2K02</b>	Hub. Kami

## Tiger Limit Switch



Spesifikasi	XCJ102C	XCJ103C	XCJ127C	XCJ128C
Referensi	XCJ102C	XCJ103C	XCJ127C	XCJ128C
Operator	Pendorong dan rol baja untuk pendekatan Lateral Cam	Pendorong dan rol baja untuk pendekatan Traverse Cam	Pendorong tuas rol yang datar dan pendek	Pendorong tuas rol yang datar dan panjang
Tipe	1 C/O	1 C/O	1 C/O	1 C/O
Operating Force (Max)	5.88 N	5.88 N	2.3 N	1.77 N
Harga	196.900	214.500	180.400	232.100

# Relay

## RXM-AB

• Miniatur Relay



- Tombol Tes
- Pengunci Kontak
- Label

Dilengkapi tombol tes manual

Referensi	Jumlah Pin	Jumlah Kontak (CO)	Arus	LED	Harga
RXM2AB1●●	8	2	12	-	103.400
RXM2AB2●●	8	2	12	Ya	116.600
RXM4AB1●●	14	4	6	-	105.600
RXM4AB2●●	14	4	6	Ya	116.600

Catatan: Gantikan kode ●● pada referensi untuk tegangan kontrol koil sesuai tabel dibawah.

Koil	24 V DC	230 V AC
Kode**	BD (1)	P7 (1)

- Untuk tipe tegangan koil lainnya silakan menghubungi customer care center kami.
- Dilengkapi dengan tombol tes manual

## RXM-AB

• Socket



Terminal terpisah antara koil dan kontak digunakan untuk menghindari kesalahan pengkabelan.

Logic style socket separated termination

Referensi	Untuk Tipe Relay	Terminal	Koneksi	Harga
RXZE2S108M	RXM2	Terpisah	Konektor	47.300
RXZE2S114M	RXM4	Terpisah	Konektor	53.900

## RXM-LB

• Miniatur Relay



- Status Relay Mekanikal
- LED Indikator

- Bentuk lebih ringkas
- Kemudahan dalam pemasangan/ penggantian 1 to 1 replacement.
- Tersedia 2/4 kontak CO, 24 VDC & 220 VAC

Referensi	Jumlah Pin	Jumlah Kontak (CO)	Arus	LED	Harga
RXM2LB1●●	8	2	5	-	61.600
RXM2LB2●●	8	2	5	Ya	64.900
RXM4LB1●●	14	4	3	-	69.300
RXM4LB2●●	14	4	3	Ya	75.900

Catatan: Gantikan kode ●● pada referensi untuk tegangan kontrol koil sesuai tabel dibawah.

Koil	24 V DC	230 V AC
Kode**	BD (1)	P7 (1)

- Untuk tipe tegangan koil lainnya silakan menghubungi customer care center kami.
- Dilengkapi dengan tombol tes manual

## RXM-LB

• Socket



Mudah dalam instalasi dan penggantian (Replacement).

Referensi	Untuk Tipe Relay	Terminal	Koneksi	Harga
RXZE1M2C	RXM2LB	Tercampur	Screw Clamp	34.100
RXZE1M4C	RXM4LB	Tercampur	Connector	41.800



### Medan

UNIPLAZA Building, East Tower, Lt 3  
Jl. Letjend. M.T. Haryono A-1  
Medan - 20231  
Ph. (62) (061) 457 9006  
Fax. (62) (061) 455 5153

### Balikpapan

Komplek Ruko Little China Blok AB 6 No 7,  
Balikpapan Baru Balikpapan 76114,  
Kalimantan Timur  
Ph. (0542)-876722  
Fax. (0542)-873709

 Sales Office

 Factory

### Batam

Batamindo Industrial Park  
Jl. Beringin Blok 4  
Muka Kuning, Batam Island - 29433  
Ph. (62) (0770) 611 133  
Fax. (62) (0770) 611 134

### Head Office Jakarta

Gedung Cibis Nine Park, 16th Floor  
Jalan TB Simatupang No. 2,  
Cilandak Timur, Jakarta Selatan -  
DKI Jakarta - 12560  
Phone: (021) 5096 6000

### APC By Schneider Electric

Gedung Cibis Nine Park, 16th Floor  
Jalan TB Simatupang No. 2,  
Cilandak Timur, Jakarta Selatan -  
DKI Jakarta - 12560  
Phone: (021) 5096 6000

### Cikarang

East Jakarta Industrial Park (EJIP)  
Plot 4B no.1-2, Lemah Abang  
Bekasi 17550, Jawa Barat  
Ph. (62) (21) 897 0203-8  
Fax. (62) (21) 897 0209, 897 0085

### Surabaya

Gedung Graha Pena Lantai 3 Ruang 302  
JL. Jendral A. Yani no 88, Surabaya 60234  
Ph. (62) (031) 8288333 ( Hunting )  
Fax. (62) (031) 8299901

## CUSTOMER CARE CENTER

Sejak tahun 1999, PT Schneider Indonesia sangat menyadari pentingnya peranan Customer Care Center dalam menunjang dan meningkatkan pelayanan kepuasan pelanggan seiring dengan visi perusahaan.

Customer care center secara terus menerus mengembangkan dan meningkatkan kemampuan para karyawannya serta perangkat lunak dan perangkat keras sehingga kami dapat melayani seluruh pelanggan di wilayah nusantara.

Unduh aplikasi mySchneider dengan QR code scanning. Silakan akses aplikasi untuk:

- Informasi stock barang
- Informasi umum tentang produk
- Informasi harga



## PELAYANAN

- Informasi Status Pesanan Barang
- Spesifikasi Produk
- Aplikasi Teknik
- Online Trouble Shooting
- Keluhan Pelanggan



Life Is On

**Schneider**  
Electric

Hotline

1500055

F. (+62) (21) 750 4415-16

E. [customercare.id@se.com](mailto:customercare.id@se.com)

[se.com/id](https://se.com/id)